

Bench Top Tube Bender

User's Manual

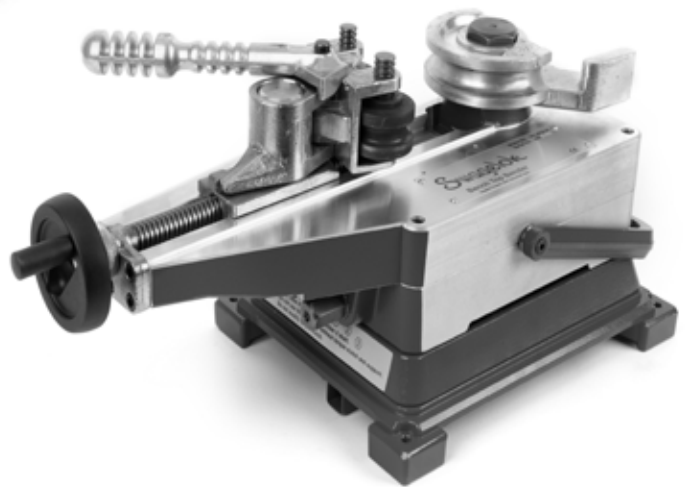
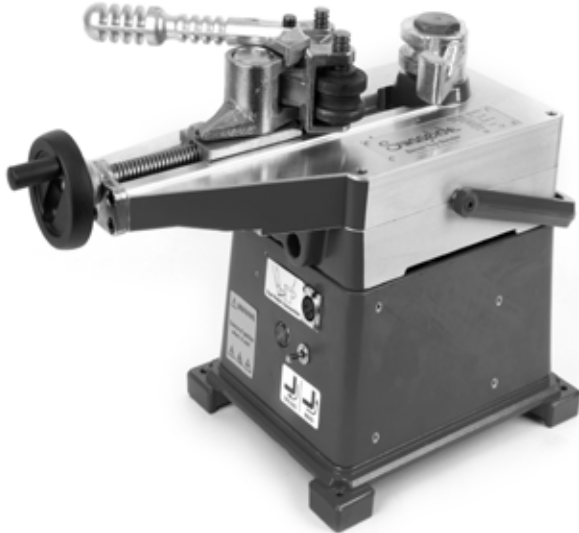

- Electric and manual units
- Bends fractional and metric tubing
- CE marked
- UKCA marked

Swagelok®

Contents

Safety Instructions	2	Measuring the Bend Angle	16
Technical Data	2	Bend Data Tables	
Tubing Data	3	Fractional Tubing	17
Bend Layout	4	Metric Tubing	24
Manual Bender		Fractional Tubing with Metric Dimensions	30
Product Information	6	Minimum Length of Last Leg	
Setup	7	Fractional Tubing	37
Calibration	8	Metric Tubing	38
Unloading the Bender	9	Fractional Tubing with Metric Dimensions	39
Operation	10	Maintenance	40
Electric Bender		Replacement Parts	41
Product Information	11	Accessories	43
Setup	12	Troubleshooting	44
Calibration	14	Warranty	44
Unloading the Bender	14		
Operation	15		

Safety Instructions

READ THIS MANUAL BEFORE USING THE BENCH TOP TUBE BENDER.



WARNING

Statements that identify conditions or practices that could result in death or serious injury.



CAUTION

Statements that identify conditions or practices that could result in minor or moderate injury or damage to property.



CAUTION - EYE PROTECTION

Eye protection must be worn while operating or working near equipment.



CAUTION - PINCH POINTS

Keep hands, loose clothing, and long hair away from moving parts. Injury can occur.

Technical Data

Bending Range

1 to 180°. Do not bend tube in excess of 180°.

Dimensions (tube bender in case)

Width—21 in. (53 cm)

Depth—11 in. (28 cm)

Height—14.5 in. (37 cm)

Weight (tube bender in case, excluding tooling)

Manual unit—81 lb (37 kg)

Electric unit—84 lb (39 kg)

Power Requirements (electric unit)

MS-BTB-1—110 V (ac) 50/60 Hz; maximum current: 10 A

MS-BTB-2—230 V (ac) 50/60 Hz; maximum current: 5 A

Tubing Data

- The Swagelok bench top tube bender bends 1/4, 3/8, 1/2, 5/8, 9/16, 3/4, 7/8, 1 in., and 1 1/4 in. and 6, 10, 12, 14, 15, 16, 18, 20, 22, 25, 28, and 30 mm outside diameter tubing in a variety of wall thicknesses.
- Tubing should be free of scratches and suitable for bending and flaring.

Fractional Tubing

Tube OD	Approx Bend Radius	Carbon Steel Wall Thickness Min/Max	Stainless Steel Wall Thickness Min/Max
Dimensions, in.			
1/4	1.42	0.028/0.065	
3/8	1.42	0.035/0.065	0.035/0.083
3/8	2.20	0.035/0.065	0.035/0.083
1/2	1.42	0.035/0.083	
1/2	2.20	0.035/0.065	
5/8	1.81	0.035/0.095	0.049/0.095
3/4	2.20	0.049/0.109	
7/8	2.64	0.049/0.109	
1	3.23	0.049/0.120	0.065/0.120
1 1/4	4.41	0.065/0.120	0.083/0.120

Suggested Tubing Ordering Information

High-quality, soft-annealed, seamless carbon steel hydraulic tubing ASTM A179 or equivalent. Hardness 72 HRB (130 HV) or less.

Fully annealed, high-quality (Type 304, 316, etc.) (seamless or welded and drawn) stainless steel hydraulic tubing ASTM A269 or A213, or equivalent. Hardness 80 HRB (114 HV) or less.

Nominal Tube OD	Approx Bend Radius	Medium-Pressure Tubing		IPT Series Tubing	
		Heavy-Wall Annealed Stainless Steel Wall Thickness Min/Max	Cold Drawn 1/8 Hard Stainless Steel Wall Thickness Min/Max	Medium-Pressure Stainless Steel Wall Thickness	High-Pressure Stainless Steel Wall Thickness
Dimensions, in.					
1/4	1.42	0.065/0.095	0.028/0.065	0.071	0.084
3/8	1.42	0.083/0.134	0.035/0.083	—	—
3/8	2.20	0.083/0.134	0.035/0.083	0.086	0.125
1/2	1.42	0.083/0.188	0.049/0.109	—	—
9/16	3.23	—	—	0.125	0.187

Suggested Tubing Ordering Information

Seamless, austenitic, cold-drawn tubing ASTM A213 or equivalent. Hardness 95 HRB (210 HV) or higher.

Metric Tubing

Tube OD	Approx Bend Radius	Carbon Steel Wall Thickness Min/Max	Stainless Steel Wall Thickness Min/Max
Dimensions, mm			
6	36	0.8/1.2	
10	36	1.0/1.5	
12	36	1.0/2.2	1.0/2.0
14	46	1.0/2.2	
15	46	1.0/2.2	
16	46	1.0/2.5	1.0/2.2
18	56	1.2/2.5	
20	67	1.2/2.8	
22	67	1.2/2.8	
25	82	1.2/ 3.0	1.8/3.0
28	112	1.8/3.0	1.8/3.0
30	112	2.0/3.0	

Suggested Tubing Ordering Information

High-quality, soft-annealed, carbon steel hydraulic tubing DIN-2391 or equivalent. Hardness 130 HV (72 HRB) or less.

Fully annealed, high-quality (Type 304, 316, etc.) stainless steel tubing EN ISO 1127 or equivalent. Hardness 180 HV (80 HRB) or less.

Bend Layout

This bender can be used to form single, offset, and other bends. This section contains information for measuring and marking the tube prior to bending.

Note: Make all marks 360° around the tube.

Single Bend

1. Place a **reference mark** at the end of the tube from which you are beginning the measurements.
2. Measure from the **reference mark** and make a **measurement mark** on the tube at a distance equal to the **length of first leg**. This mark is the vertex of the bend.
3. Measure the **bend deduction distance** for the angle being bent from the **measurement mark** (see Bend Data Tables beginning on page 17) and make a **bend mark** on the tube.
 - If the bend deduction is positive, place the bend mark toward the reference mark.
 - If the bend deduction is negative, place the bend mark away from the reference mark.
4. Refer to the appropriate **Operation** section to bend the tube.

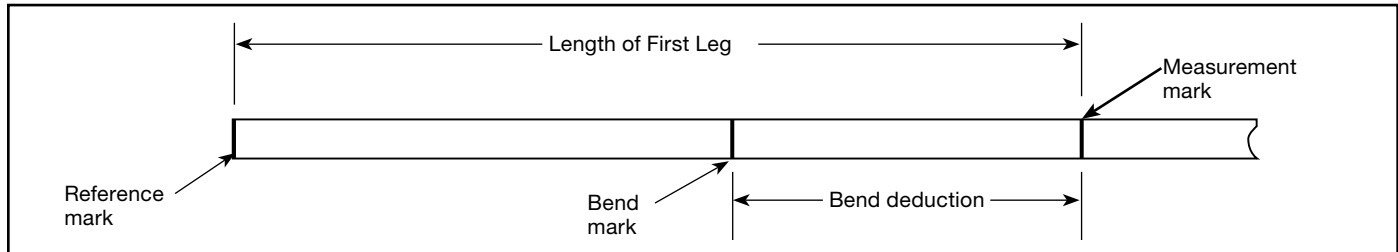

Single Bend

Multiple Bends

The Measure-Bend Method

1. Follow Single Bend steps 1 through 4.
2. Using the vertex of the previous bend as the reference mark, repeat steps 2 through 4 for the next leg. (The vertex is where the center lines of the two legs of the angle intersect.)

Example:

Using 5/8 in. OD tube and an aluminum bend shoe, make a 90° bend 12 inches from the reference mark followed by a 45° bend with 12 inches between bends.

1. Place a **reference mark** at the end of the tube from which you are beginning the measurements.

For the first leg:

2. Measure 12 inches from the **reference mark** and make a **measurement mark** to indicate the **end of the first leg**.
3. The **bend deduction** in the **Fractional Tubing Bend Data** table for a 90° bend using 5/8 in. tubing and an aluminum bend shoe is 1 3/4 in.
4. Place the **bend mark** 1 3/4 in. from the **measurement mark** going towards the **reference mark**.
5. Bend tube 90° according to the appropriate **Operation** section.

For the second leg:

6. Measure 12 inches from the vertex of the 90° bend and make a second measurement mark, away from the reference mark.
7. The bend deduction distance in the **Fractional Tubing Bend Data** table for a 45° bend using 5/8 in. tubing and an aluminum bend shoe is 11/16 in.
8. Place a second bend mark 11/16 in. from the second measurement mark going towards the first bend.
9. Bend tube according to the appropriate **Operation** section.

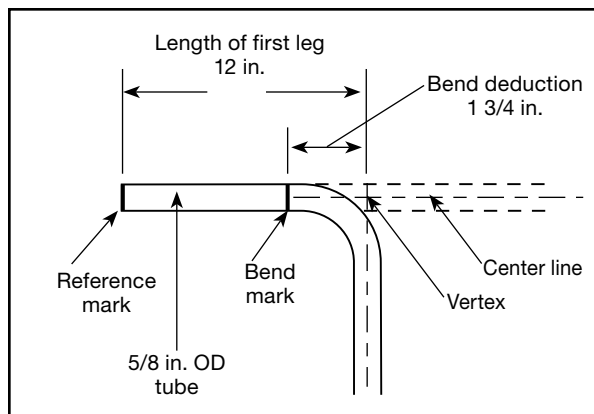

First Bend (90°)

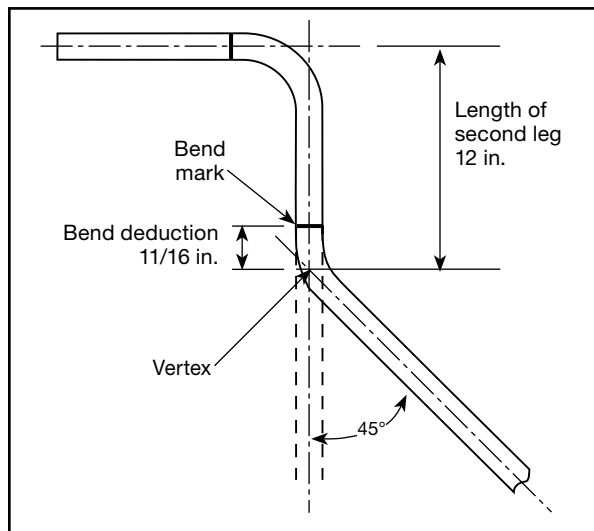

Second Bend (45°)

Reverse Bends

The Measure-Bend Method

Sometimes a multiple bend layout will require that a bend be made in reverse. A reverse bend is made with the end of the tube opposite the reference mark inserted into the bend shoe rather than the end with the reference mark.

1. Measure from the vertex of the preceding bend and place a second measurement mark farther down the tube at a distance equal to the desired length of the leg.
2. Measuring from that measurement mark, place a bend mark on the tube at the bend allowance for the angle being bent. (See Bend Data tables beginning on page 17).
 - If the bend allowance is positive, place the bend mark away from the preceding bend.
 - If the bend allowance is negative, place the bend mark in the direction towards the preceding bend.
3. Bend tube according to the appropriate **Operation** section.

Note: When loading the tube into the bender to make a reverse bend, ensure that the end with the reference mark is not inserted into the bend shoe.

Offset Calculations

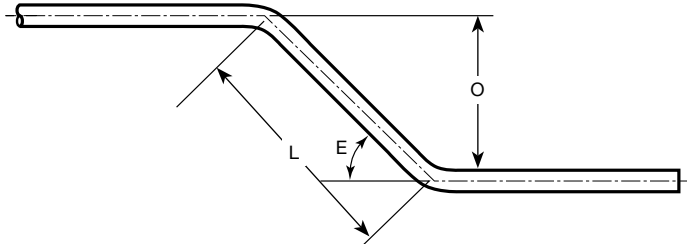

When offset exists, determine the length of offset (L) before calculating for the adjustment from the tube bend. To determine the length of offset, select the offset angle (E). Then, multiply the offset dimension (O) by the offset bend allowance.

Angle (E)	Offset Bend Allowance		Offset (O)	=	Length of Offset (L)
22.5°	2.613	×	-----	=	-----
30°	2.000	×	-----	=	-----
45°	1.414	×	-----	=	-----
60°	1.154	×	-----	=	-----

Manual Bender

Product Information

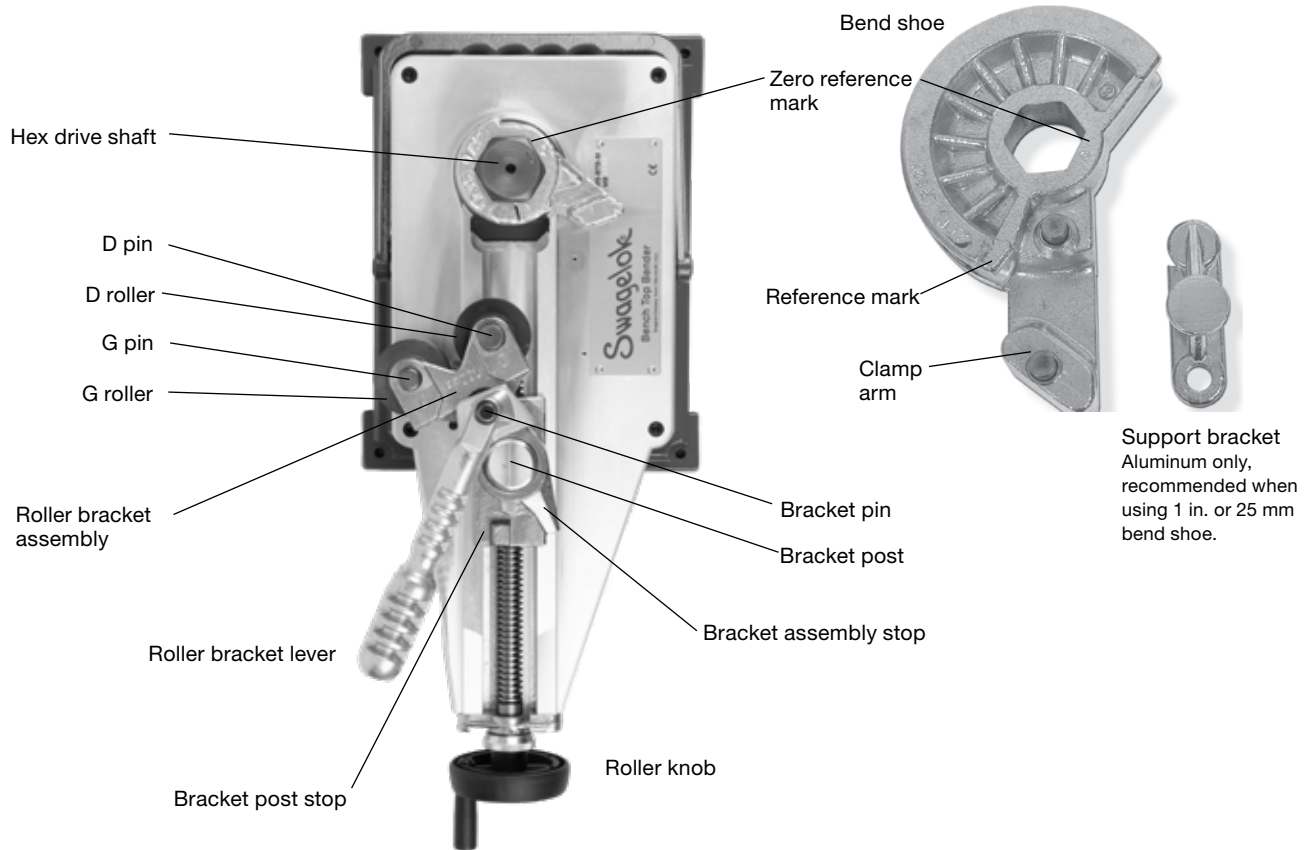
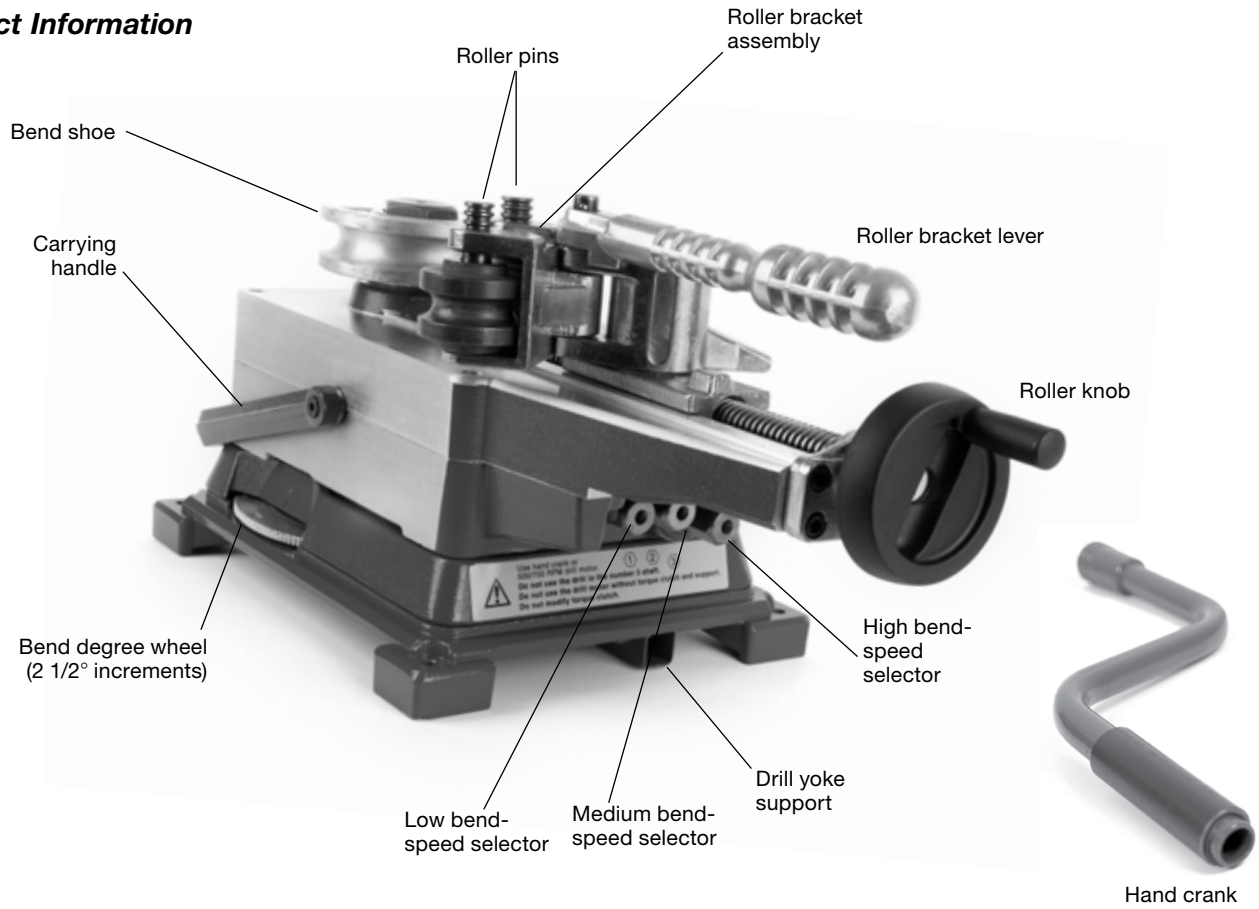

CAUTION
 When lifting the bender, first place one hand under the bender, then pick up the unit by grabbing the carrying handle with your other hand.

Setup

1. Place the hand crank on the high bend-speed selector.
2. Rotate the hand crank until the **zero reference mark** on the **hex drive shaft** is between the 2 and 3 o'clock position, when viewed from the operating position.

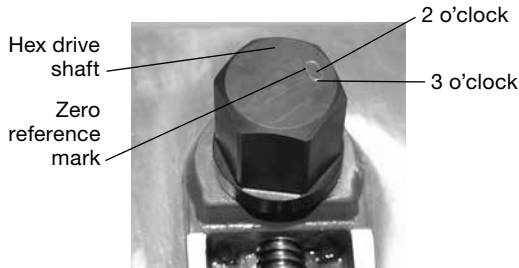

3. Rotate the **roller knob** counterclockwise until it stops.



4. Place the appropriate **bend shoe** on the **hex drive shaft**, aligning the **zero reference marks** on the shoe and the shaft. The bend shoe must be fully bottomed on the hex drive shaft.

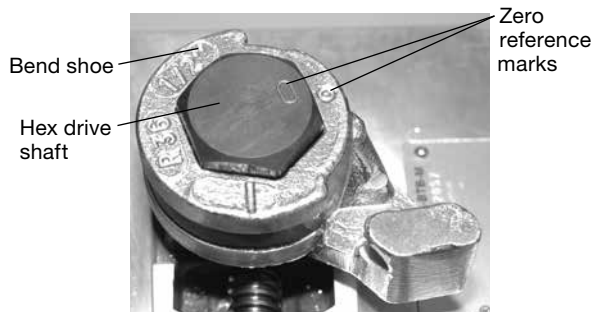

5. Install the **roller bracket assembly** on the **bracket post**.

Note: The **roller bracket assembly stop** must be to the right of the **bracket post stop**.

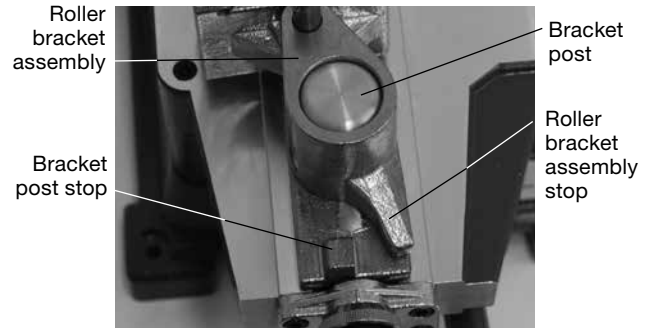

6. Place the roller bracket lever on the bracket pin.
 Note: The lever must be fully bottomed on the pin.
7. Lift the **roller pins**, place the appropriate **rollers** in the marked locations on the **roller bracket**, and replace the roller pins.



Note: The roller pins must be fully engaged with the roller bracket assembly.

8. Mark tube according to **Bend Layout**.
9. Carefully insert the **tube** into the **bend shoe**, past the **clamp arm**.

Caution
 The end of the tube must extend past the right edge of the clamp arm to prevent potential damage to the tube during bending.

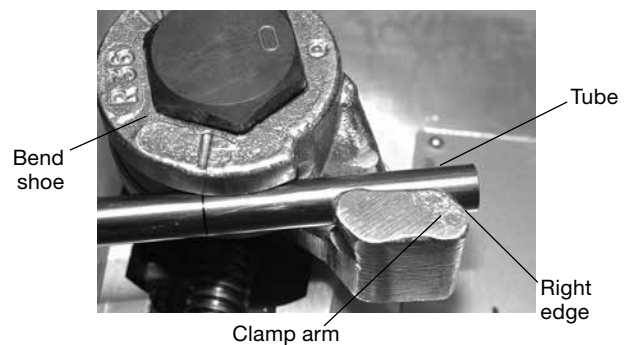

10. Align the **bend mark** on the **tube** with the **reference mark** on the **bend shoe**.



11. Turn the roller bracket lever clockwise until the **roller bracket assembly stop** makes contact with the **bracket post stop**.

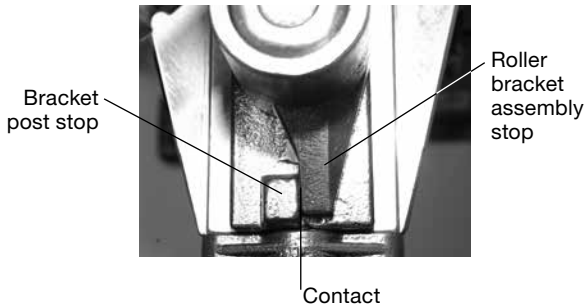

12. Hold the tube and turn the roller knob clockwise until the G and D rollers both make contact with the tube and the roller knob is tight.

Note: The rollers may need to be guided onto smaller diameter tubing.

13. Ensure there is approximately 3/8 in. or 10 mm clearance between the **D roller** and the **clamp arm** of the bend shoe.

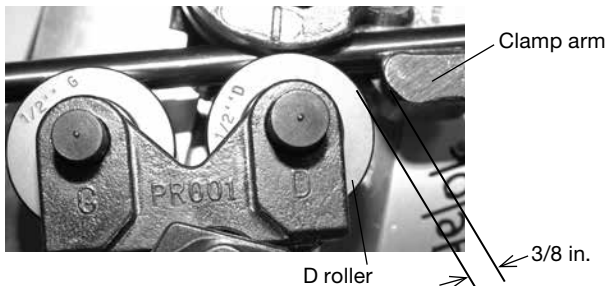

To *increase* clearance:

Rotate the roller knob counterclockwise while slowly rotating the hand crank clockwise and maintaining straight tube.

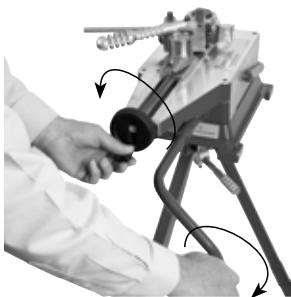

To *decrease* clearance:

Rotate the roller knob clockwise while slowly rotating the hand crank counterclockwise.

Note: The roller knob must be tight.

Note: Do **not** turn the roller knob after this point or bend consistency **will be** affected.

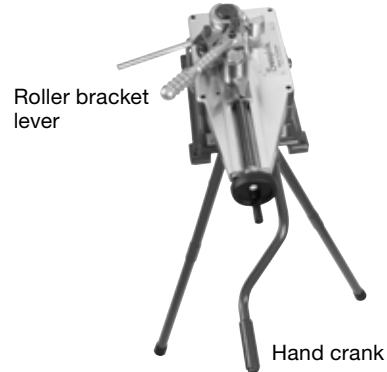

Calibration

Calibration is the process of positioning the bend degree wheel to accurately display the angle being generated by the bender.

Calibration accounts for tube variables and mechanical play in the bender, which is typically observed as springback. Different materials, different lots of the same material, and different wall thicknesses of the same material may exhibit different bend characteristics.

Once the bender has been calibrated, recalibration is recommended whenever:

- OD or wall thickness of tube being bent is changed.
- The roller knob has been turned after Calibration completed.
- The bend degree wheel does not accurately display the bend angle.

1. Place the **hand crank** on the desired **speed selector** for the tube being bent.
 - Low bend-speed selector (1) is suggested for large diameter or heavy-wall tube.
 - Medium bend-speed selector (2) is suggested for intermediate size and medium-wall tube.
 - High bend-speed selector (3) is suggested for small diameter and thin-wall tube.
2. Slowly rotate the hand crank until the tube begins to deflect or bend (looking to the right of the rollers).
 - On low (1) and high (3) bend speeds, rotate the hand crank clockwise.
 - On medium (2) bend speed, rotate the hand crank counter-clockwise.
3. Keep the hand crank still and rotate the bend degree

wheel to zero.

⚠ Caution
Releasing the hand crank while tube is under load may cause the hand crank to spin, possibly leading to injury.

4. Rotate the hand crank until the bend wheel displays 5° less than the desired bend angle. This will prevent setup scrap due to overbending.

Example: For a desired bend angle of 90°, rotate the hand crank until the bend degree wheel reads 85°.

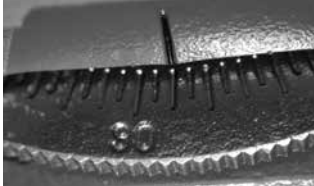

5. Unload the bender (see **Unloading the Bender**) and measure the bend angle of the tube (see **Measuring the Bend Angle**). Make note of this measurement as it is likely to be different than the angle displayed on the bend wheel.
6. Reload the tube into the bender, lining up the bend mark and the reference mark.
7. Rotate the hand crank until the bend degree wheel reads the angle from step 4 (in example: 85°).

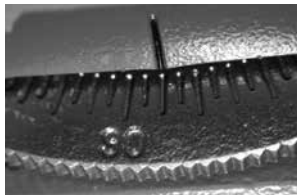

8. Keep the hand crank still and rotate the bend degree wheel to the measurement noted in step 5 (in example: 88°). This calibrates the bend degree wheel by setting it to display the actual bend angle being produced.

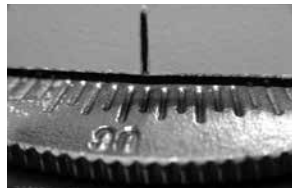

9. Continue to rotate the hand crank until the bend degree wheel reads the desired bend angle.

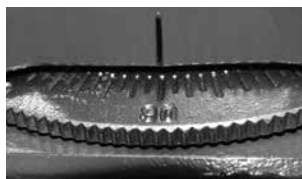

10. Unload the bender (see **Unloading the Bender**) and measure the bend angle of the tube.

The bend angle indicated on the bend degree wheel will now be very close to the bend angle produced. If further adjustment is desired repeat steps 6 through 10.

Note: Tube springback is cumulative. Depending on the tube variables, a smaller bend angle builds up less tube springback during the bending process than a larger bend angle. For example, if a 30° bend is attempted using a bender that was calibrated to make a 90° bend, the resulting bend may be larger than desired. Conversely, if a 150° bend is attempted on the same bender, the resulting bend may be smaller than desired. It is advised to verify each bend angle.

Unloading the Bender

Note: Do **not** turn the roller knob to unload the bender. Doing so **will affect** bend consistency.

⚠ Caution
Releasing the hand crank while the tube is under load may cause the hand crank to spin, possibly leading to injury.

1. Rotate the hand crank in the direction opposite that used to bend the tube.
2. As the hand crank is rotated, gently push the roller bracket lever counter-clockwise until the rollers swing away from the tube and the tube can be removed from the bender.

Note: Do not force the roller bracket lever.

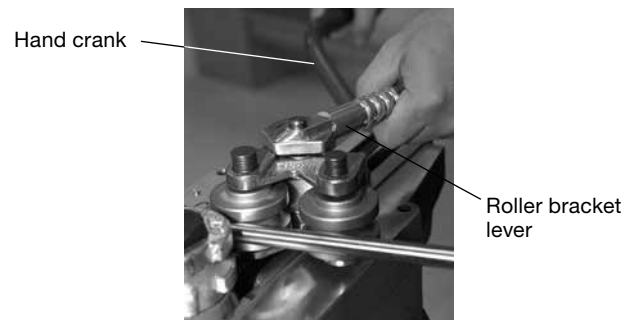

Operation

Before operating the bender mark the tube (see **Bend Layout**) and follow the **Setup** and **Calibration** procedures.

CAUTION - PINCH POINTS

1. With the zero reference mark between the 2 and 3 o'clock position, place the hand crank on the desired speed selector.
 - Low bend-speed selector (1) is suggested for large diameter or heavy-wall tube.
 - Medium bend-speed selector (2) is suggested for intermediate size and medium wall tube.
 - High bend-speed selector (3) is suggested for small diameter and thin-wall tube.
2. Insert the **tube** carefully into the grooved section of the **bend shoe**, past the **clamp arm**.

CAUTION

The end of the tube must extend past the **right edge** of the clamp arm to prevent potential damage to the tube during bending.

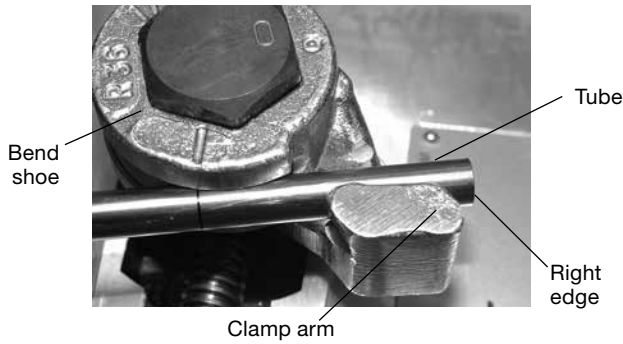

3. Align the **bend mark** on the tube with the **reference mark** on the bend shoe.

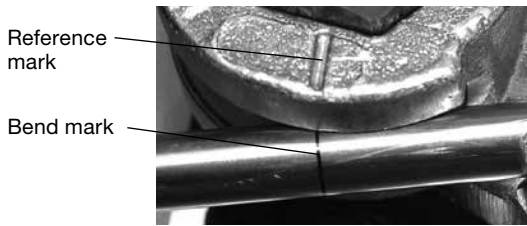

4. Turn the **roller bracket lever** clockwise until the **roller bracket assembly stop** and the **bracket post stop** make contact.

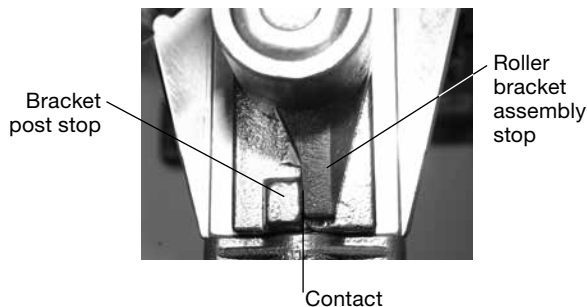

Note: If the rollers touch the tube and prevent the stops from making contact, gently turn the roller bracket lever clockwise while rotating the **hand crank**.

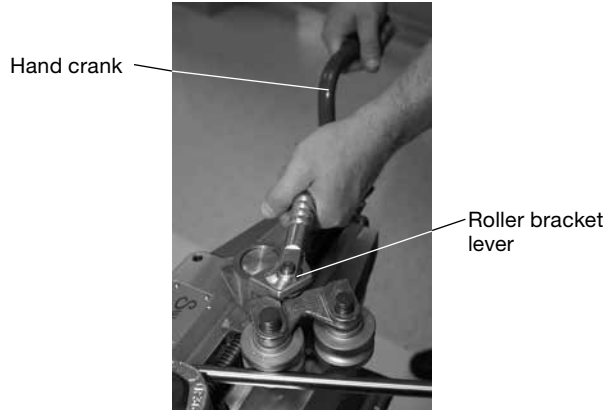

5. Check the following before continuing:
 - The bend mark remains aligned with the reference mark on the bend shoe.
 - The tube is positioned in the correct plane for bend.
 - The tube will not contact the bender housing during the bend operation (for a multiple bend).



6. Rotate the hand crank until you reach the desired bend angle on the bend degree wheel.
 - On low (1) and high (3) bend speeds, rotate the hand crank clockwise to bend the tube.
 - On medium (2) bend speed, rotate the hand crank counter-clockwise to bend the tube.
7. Unload the tube from the bender. See **Unloading the Bender**.
8. Verify the bend angle (see **Measuring the Bend Angle**). Make adjustments if necessary (see **Calibration**).
9. Use the hand crank on the high bend-speed selector (3) to return the bend shoe to the starting position.

Note: Do **not** turn the roller knob or bend consistency **will be** affected.

Electric Bender
Product Information

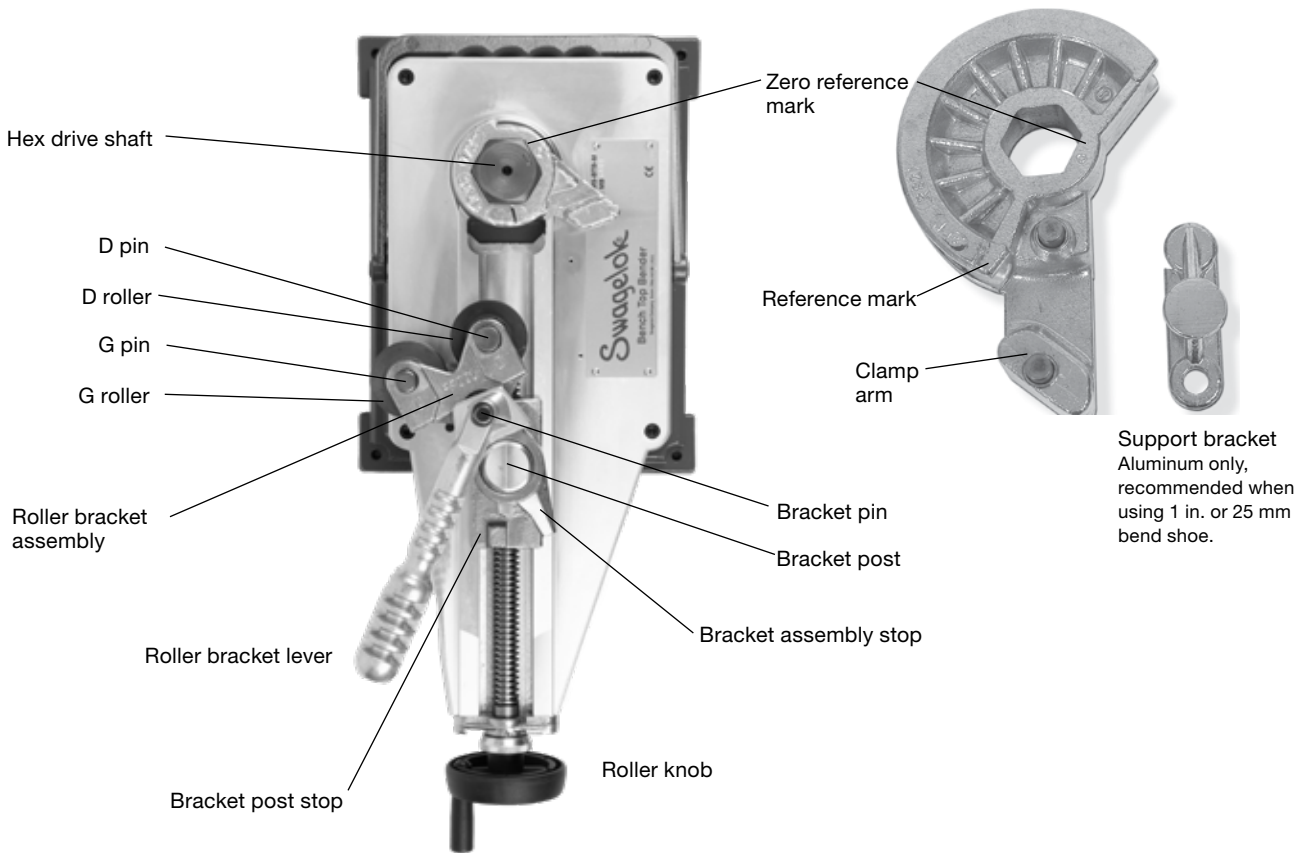
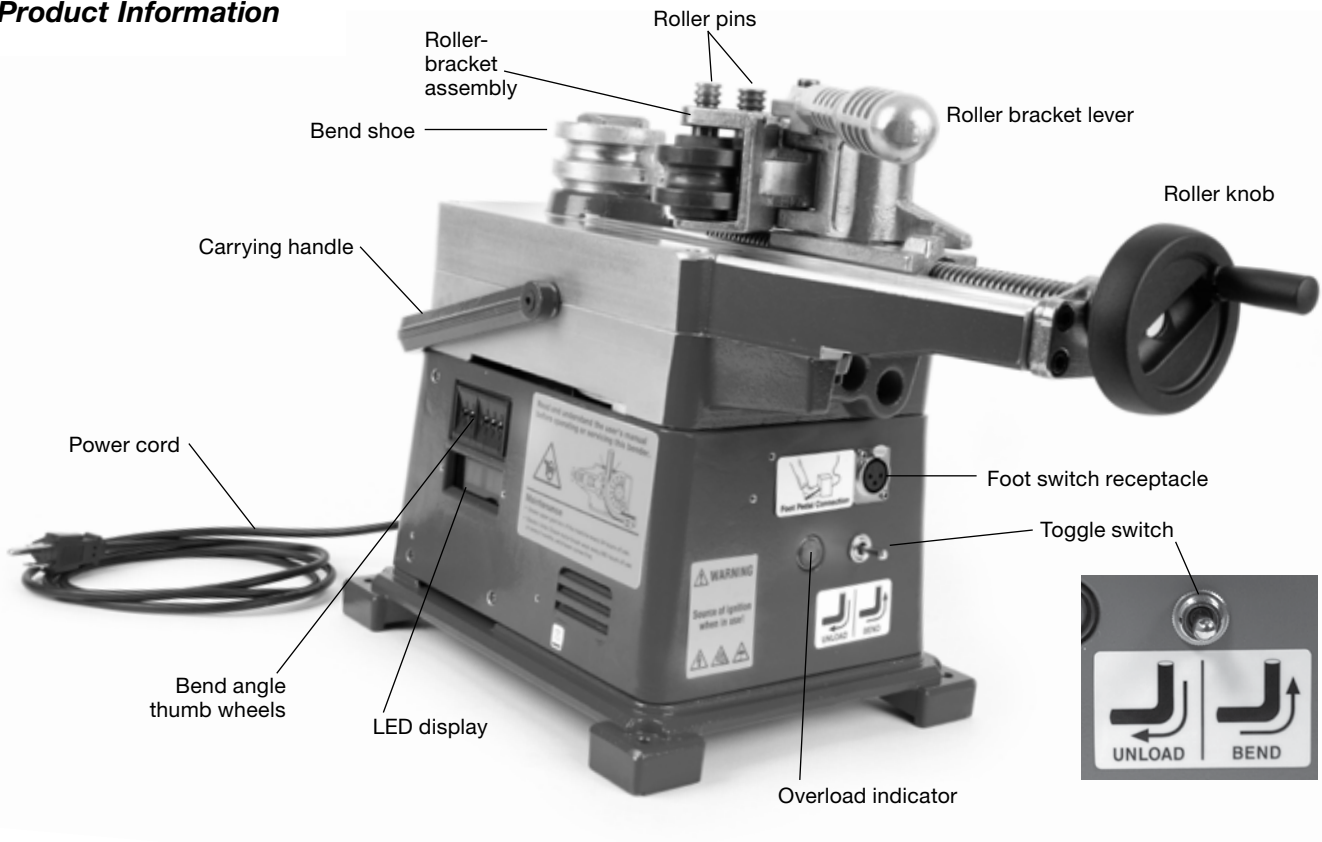

Electric bender must be operated in a safe environment to avoid risk of fire, explosion, or electric shock.

⚠ WARNING
Voltage greater than 30 V (ac) is present.

⚠ WARNING - KEEP DRY.
Do not expose the equipment to water or wet locations.

⚠ WARNING - FIRE OR EXPLOSION.
Do not use equipment in a combustible or explosive atmosphere. Flammable liquids or gases could ignite.

Grounding and Extension Cord Information

⚠ WARNING
Electric bender must be grounded against electrical shock. It is equipped with a three-wire conductor and three-prong plug to fit a grounded receptacle. Never connect the green or green/yellow wire to a live terminal.

⚠ WARNING
For safe operation of the electric bender, the extension cord wire size must meet the following specifications:
For 0 to 25 ft (0 to 7.5 m), the recommended minimum wire gauge is 14 AWG or 1.5 mm.
For 25 to 50 ft (7.5 to 15 m), the recommended minimum wire gauge is 12 AWG or 2.5 mm.

⚠ CAUTION
When lifting the bender, first place one hand under the bender, then pick up the unit by grabbing the carrying handle with your other hand.

Setup

It is recommended that scrap tube be used during setup and calibration of the Electric Bench Top Tube Bender.

1. Plug in the **power cord**.
2. Hold the **toggle switch** in the **unload** direction until the motor stops. The **zero reference mark** on the **hex drive shaft** should now be between the 2 and 3 o'clock position.

Note: The toggle switch is programmed to have a safety time delay of approximately two seconds between operations.

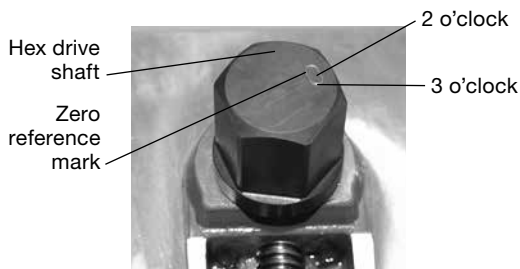

3. Rotate the **roller knob** counterclockwise until it stops.

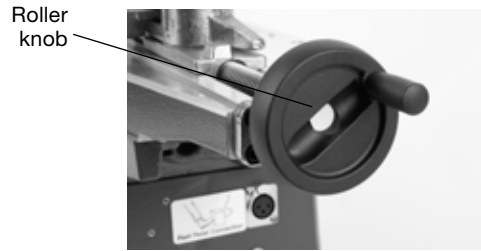

4. Place the appropriate **bend shoe** on the **hex drive shaft**, aligning the **zero reference marks** on the shoe and the shaft. The bend shoe must be fully bottomed on the hex drive shaft.

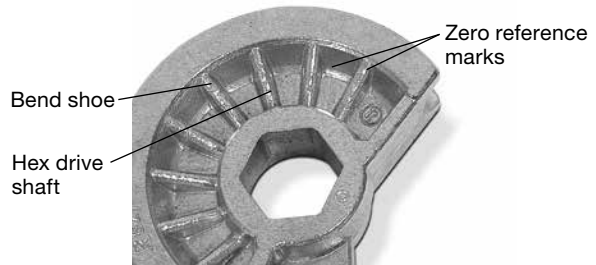

5. Install the **roller bracket assembly** on the **bracket post**.
Note: The **roller bracket assembly stop** must be to the right of the **bracket post stop**.

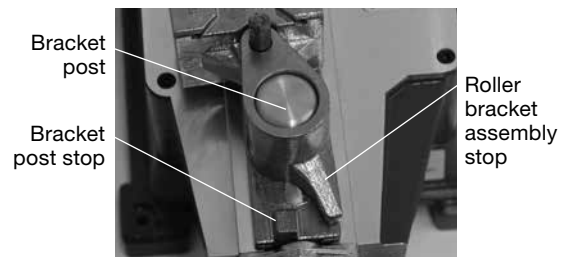

6. Place the roller bracket lever on the bracket pin.
Note: The lever must be fully bottomed on the pin.
7. Lift the **roller pins**, place the **G and D rollers** in the marked locations on the **roller bracket**, and replace the roller pins.
Note: The roller pins must be fully engaged into the **roller bracket assembly**.

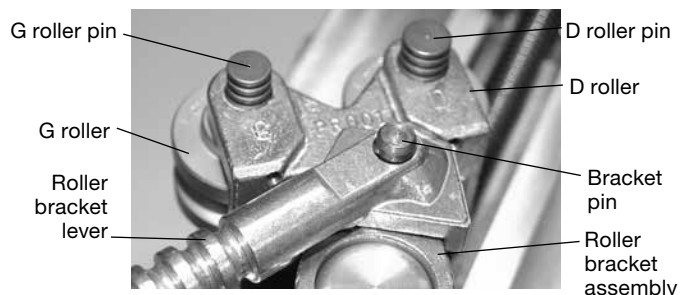

- Carefully insert the **tube** into the **bend shoe**, past the **clamp arm**.

CAUTION
 The end of the tube must extend past the right edge of the clamp arm to prevent potential damage to the tube during bending.

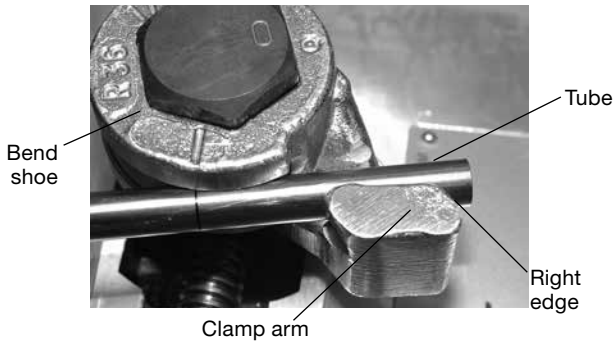

- Turn the roller bracket lever clockwise until the roller bracket assembly stop makes contact with the bracket post stop.

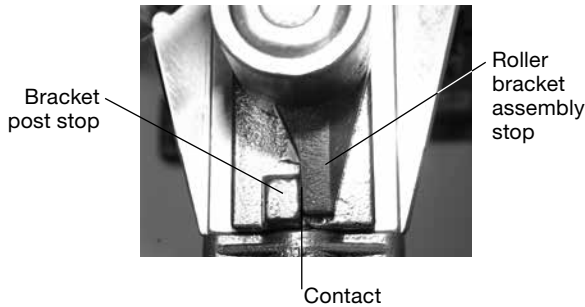

- Hold the tube in the bend shoe and turn the roller knob clockwise until both the G and D rollers make contact with the tube.
 Note: Smaller diameter tube may need to be guided into the rollers.

- Once the roller knob is tight, the following conditions must be met:
 - The roller bracket assembly stop and the bracket post stop must maintain contact.
 - Both rollers must make contact with the tube.
 - There must be approximately 3/8 in. or 10 mm clearance between the **D roller** and the **clamp arm** of the bend shoe.



If all three conditions *are* met, make note of the value appearing on the three right bend angle thumb wheels and proceed to **Calibration**.

If all three conditions *are not* met:

- Turn the roller knob counter-clockwise until the tube can be removed. Remove tube.
- Advance the right-most **bend angle thumb wheel** one digit.

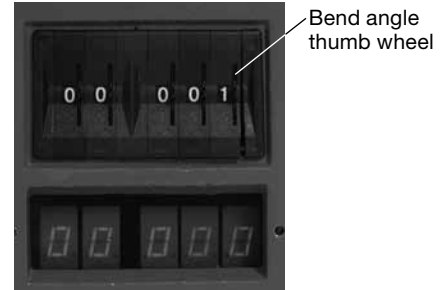

- Hold the toggle switch in the bend direction until the motor stops.



- Repeat steps 9 through 11 until all three conditions are met.

- Make note of the value on the right-most **bend angle thumb wheel**.

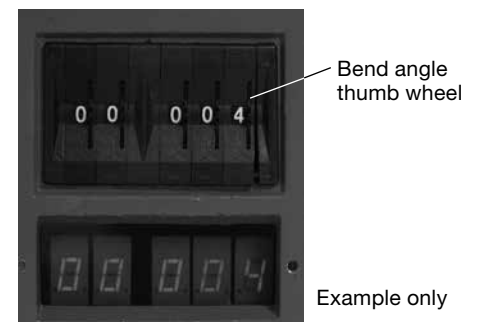

- Turn the roller knob counter-clockwise until the tube can be removed. Remove tube.
- Advance the two right-most bend angle thumb wheels until they display 010 or higher.
- Hold the toggle switch in the bend direction until the motor stops. Wait two seconds, then hold the toggle switch in the unload direction until the motor stops.
- Proceed to **Calibration**.

Calibration

Calibration is the process of accurately accounting for tube variables and mechanical play in the bender, which is typically observed as springback. Different materials, different lots of the same material, and different wall thicknesses of the same material may exhibit different bend characteristics.

Once the bender has been calibrated, recalibration is recommended whenever:

- OD or wall thickness of tube being bent is changed.
- The roller knob has been turned after Calibration has been completed.

1. Set the right-most bend angle thumb wheel to the value noted in step 12 of **Setup**. Hold the toggle switch in the bend direction until the motor stops (do not jog the switch).

2. Carefully insert the tube into the **bend shoe**, past the **clamp arm**.

CAUTION

The end of the tube must extend past the right edge of the clamp arm to prevent potential damage to the tube during bending.

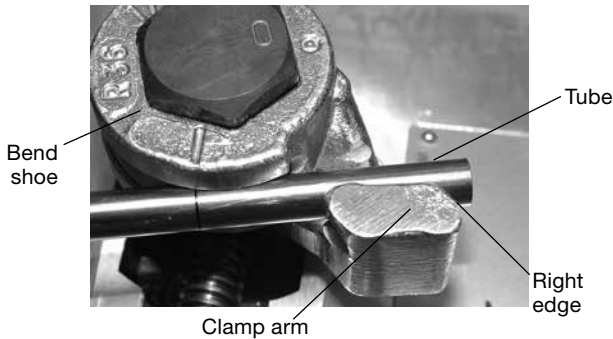

3. Turn the roller bracket lever clockwise until the **roller bracket assembly stop** makes contact with the **bracket post stop**.

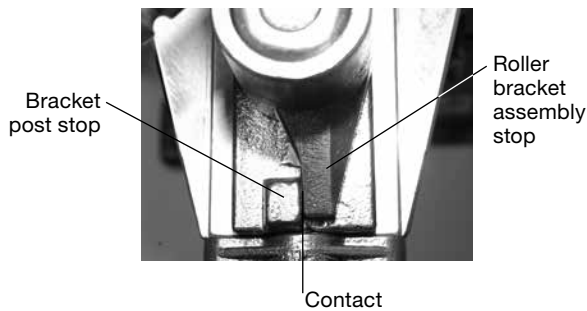

4. Hold the tube in the bend shoe and turn the roller knob clockwise until the G and D rollers both make contact with the tube.

Note: The rollers may need to be guided onto smaller diameter tubing.

Note: The clearance between the D roller and the clamp arm will now be approximately 1/4 in.

Note: Do **not** turn the roller knob after this point or bend consistency **will be** affected.

5. Set the bend angle thumb wheels to the desired bend angle.
6. Hold the toggle switch in the bend direction until the motor stops (do not jog the switch).

CAUTION - PINCH POINT

7. Unload the bender (see **Unloading the Bender**) and measure the bend angle of the tube (see **Measuring the Bend Angle**).

If the actual bend is smaller than the desired bend angle: Subtract the actual bend angle from the desired bend angle. The difference is the amount that must be *added* to the desired bend angle when setting the bend angle thumb wheels for all subsequent bends made with this tube.

For example:

The desired bend angle entered is 90°.

The resulting calibration sample measures 86°.

$$90 - 86 = 4.$$

The bend angle thumb wheels must be set 4° more than the desired bend angle for subsequent bends with this size tube, i.e. for a 90° bend, the bend angle thumb wheels must be set at 94°.

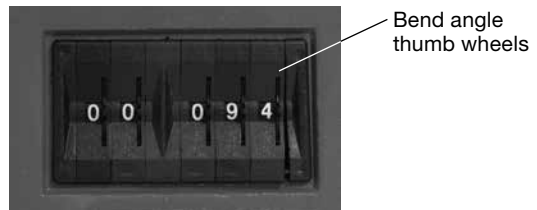

If the actual bend is larger than the desired bend angle: Subtract the desired bend angle from the actual bend angle. The difference is the amount that must be subtracted from the desired bend angle for all subsequent bends made with this tube.

For example:

The desired bend angle entered is 90°.

The resulting calibration sample measures 92°.

$$92 - 90 = 2.$$

The bend angle thumb wheels must be set 2° less than the desired bend angle for subsequent bends with this size tube, i.e. for a 90° bend, the bend angle thumb wheels must be set at 88°.

8. Make note of this amount.

Note: Tube springback is cumulative. Depending on the tube variables, a smaller bend angle builds up less tube springback during the bending process than a larger bend angle. For example, if a 30° bend is attempted using a bender that was calibrated to make a 90° bend, the resulting bend may be larger than desired. Conversely, if a 150° bend is attempted on the same bender, the resulting bend may be smaller than desired. It is advised to verify each bend angle.

Unloading the Bender

Note: Do **not** turn the roller knob to unload the bender. Doing so **will affect** bend consistency.

1. Hold the **toggle switch** in the unload position until the motor stops. While holding the toggle switch, gently turn the **roller bracket lever** counter-clockwise until the rollers swing away from the tube.

Note: Do not force the roller bracket lever.

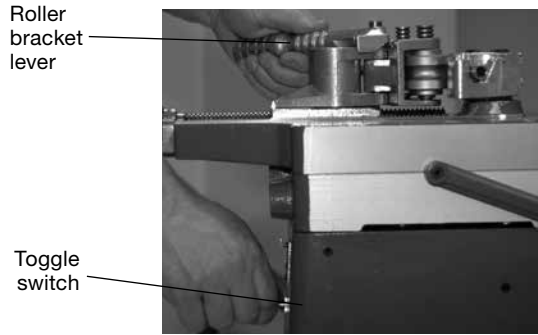

2. Hold the tube until the motor stops and the tube can be removed from the bender.

Operation

Before operating the bender mark the tube (see **Bend Layout**) and follow the **Setup** and **Calibration** procedures.

CAUTION - PINCH POINTS

1. Set the **bend angle thumb wheels** to the value noted in step 12 of **Setup**.

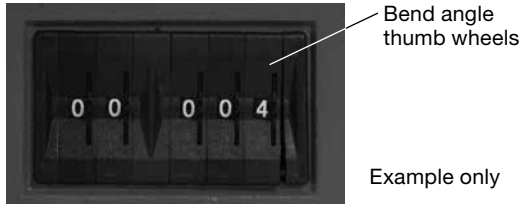

2. Hold the toggle switch in the bend direction until the motor stops (do not jog the switch).
3. Set the **bend angle thumb wheels** to the desired bend angle plus or minus the amount noted in step 8 of **Calibration**.

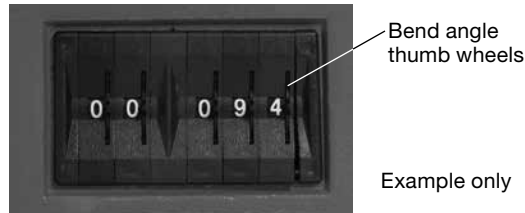

4. Carefully insert the **tube** into the **bend shoe**, past the **clamp arm**.

Caution
The end of the tube must extend past the right edge of the tube clamp support area to prevent potential damage to the tube during bending.

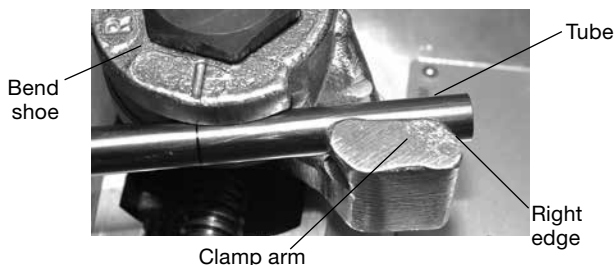

5. Align the **bend mark** on the tube with the **reference mark** on the bend shoe (see **Bend Layout** for marking tube).



6. Rotate the **roller bracket lever** clockwise until the roller bracket assembly stop and the bracket post stop make contact.

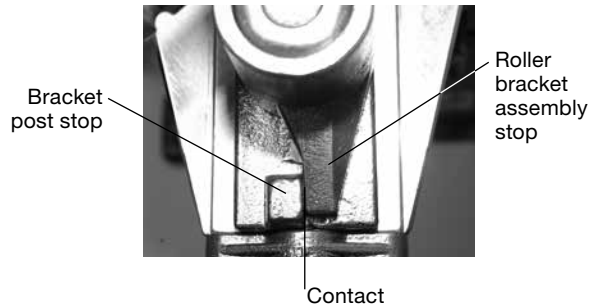

Note: The clearance between the D roller and the clamp arm will now be approximately 1/4 in.

7. Check the following before continuing:
 - The bend mark remains aligned with the reference mark on the bend shoe.
 - The tube is positioned in the correct plane.
 - The tube will not contact the bender housing during the bend operation (for a multiple bend).

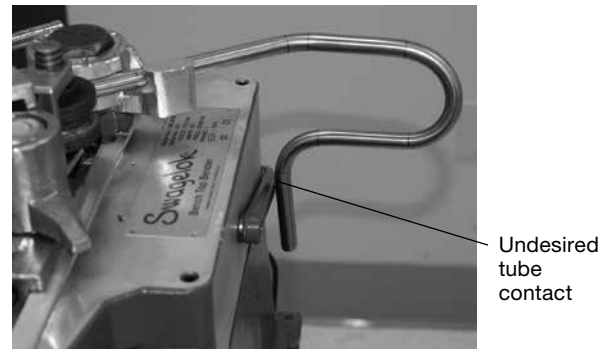

8. Hold the tube and push the toggle switch in the bend direction until the motor stops (do not jog the switch).
9. Unload the tube. See **Unloading the Bender**.
10. Verify the bend angle (see **Measuring the Bend Angle**).

Measuring the Bend Angle

This is one of many methods that may be used to measure the bend angle.

A protractor will be needed for this method.

1. Place the bent **tube** on a piece of paper with the **vertex** of the bend on the paper.

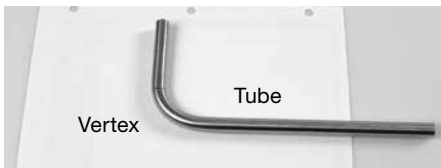

2. Hold the tube against the paper, and mark the paper along one edge of each leg of the bend with a pencil.



3. Align a ruler or other straight edge on one of the marks, and extend it past the point where it will intersect with the second mark when it is extended.
4. Repeat step 3 with the second mark. The intersection point of the two marks represents the vertex of the bend.

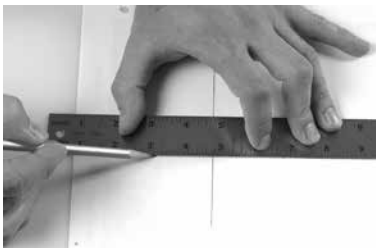

5. Place the **origin** of the protractor on the intersection of the line. Rotate the protractor so the baseline of the protractor is aligned with one of the marks and the second mark intersects the scale on the protractor (extend the marks with a pencil if necessary).

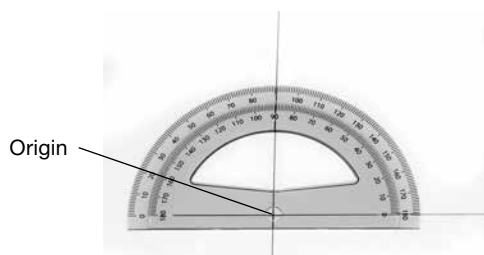

6. The second mark indicates the bend angle.
Note: The protractor will contain two scales. Read the appropriate scale.

Bend Data Tables

The bend data provided reflects results achieved using the Swagelok bench top tube bender.

Bend deduction – the distance from the vertex of the angle back to the point where the tube breaks tangent and the bend actually begins. Sometimes referred to as 'setback', 'take-up' or 'take-off'.

Bend length – the actual amount of tube consumed by the bend as measured along the centerline of the bend.

Adjustment (gain) – the difference between the actual length of tube used in a bend and the theoretical distance around a sharp corner. The information provided in these tables accounts for adjustment (gain).

Bend allowance – the bend mark distance for reverse bends. The adjustment (gain) is pushed towards the reference mark or previous bend during reverse bends.

Fractional Tubing

Dimensions are in inches.

1/4 in. OD, 36 mm (1.42 in.) Radius Bend Shoe

Bend Angle Degrees	Carbon Steel and Stainless Steel Tubing						Medium-Pressure Tubing		
	Aluminum Bend Shoe			Steel Bend Shoe			Steel Bend Shoe		
	Bend Allowance	Bend Deduction	Bend Length	Bend Allowance	Bend Deduction	Bend Length	Bend Allowance	Bend Deduction	Bend Length
15	1/16	1/16	1/8	5/16	5/16	5/8	3/8	3/8	3/4
22 1/2	1/8	3/16	5/16	3/8	7/16	13/16	7/16	1/2	15/16
30	3/16	1/4	1/2	7/16	1/2	1	9/16	9/16	1 1/8
45	3/8	7/16	13/16	5/8	11/16	1 5/16	11/16	3/4	1 1/2
60	1/2	11/16	1 3/16	3/4	15/16	1 11/16	13/16	1	1 13/16
75	9/16	15/16	1 9/16	13/16	1 3/16	2 1/16	15/16	1 1/4	2 3/16
90	5/8	1 5/16	1 15/16	7/8	1 9/16	2 7/16	15/16	1 5/8	2 9/16
105	9/16	1 11/16	2 1/4	13/16	2	2 3/4	7/8	2 1/16	2 15/16
120	3/8	2 5/16	2 5/8	1/2	2 5/8	3 1/8	5/8	2 11/16	3 5/16
135	-1/4	3 1/4	3	-1/8	3 5/8	3 1/2	-1/16	3 11/16	3 11/16
150	-1 3/4	5 1/16	3 3/8	-1 5/8	5 1/2	3 7/8	-1 9/16	5 5/8	4 1/16
165	-6 13/16	10 9/16	3 3/4	-6 13/16	11	4 1/4	-6 3/4	11 1/8	4 7/16
180	2 13/16	1 5/16	4 1/16	3 1/16	1 9/16	4 9/16	3 3/16	1 5/8	4 3/4

1/4 in. OD, IPT Series, 36 mm (1.42 in.) Radius Bend Shoe with Effective Bend Radius of 1.59 in.

Bend Angle Degrees	IPT Series Medium- and High-Pressure Tubing		
	Steel Bend Shoe		
	Bend Allowance	Bend Deduction	Bend Length
15	5/16	5/16	11/16
22 1/2	7/16	7/16	7/8
30	9/16	9/16	1 1/16
45	11/16	13/16	1 1/2
60	7/8	1 1/16	1 15/16
75	1	1 3/8	2 5/16
90	1 1/16	1 3/4	2 3/4
105	15/16	2 1/4	3 3/16
120	11/16	2 15/16	3 9/16
135	0	4 1/16	4
150	-1 3/4	6 3/16	4 7/16
165	-7 1/2	12 5/16	4 13/16
180	3 9/16	1 3/4	5 1/4

Fractional Tubing continued

Dimensions are in inches.

3/8 in. OD, 36 mm (1.42 in.) Radius Bend Shoe

Bend Angle Degrees	Carbon Steel and Stainless Steel Tubing						Medium-Pressure Tubing		
	Aluminum Bend Shoe			Steel Bend Shoe			Steel Bend Shoe		
	Bend Allowance	Bend Deduction	Bend Length	Bend Allowance	Bend Deduction	Bend Length	Bend Allowance	Bend Deduction	Bend Length
15	-1/16	-1/16	-1/16	1/16	1/16	1/8	5/16	5/16	5/8
22 1/2	0	1/16	1/8	1/8	3/16	5/16	3/8	7/16	13/16
30	1/8	1/8	5/16	1/4	1/4	1/2	7/16	1/2	15/16
45	1/4	5/16	11/16	3/8	7/16	7/8	5/8	11/16	1 5/16
60	7/16	9/16	1	1/2	11/16	1 3/16	3/4	15/16	1 11/16
75	1/2	13/16	1 3/8	5/8	15/16	1 9/16	13/16	1 3/16	2
90	9/16	1 3/16	1 3/4	5/8	1 5/16	1 15/16	13/16	1 9/16	2 3/8
105	9/16	1 9/16	2 1/8	5/8	1 11/16	2 5/16	3/4	2	2 3/4
120	3/8	2 1/8	2 1/2	3/8	2 5/16	2 11/16	1/2	2 5/8	3 1/8
135	-3/16	3 1/16	2 7/8	-3/16	3 1/4	3 1/16	-3/16	3 5/8	3 7/16
150	-1 11/16	4 7/8	3 1/4	-1 11/16	5 1/16	3 7/16	-1 11/16	5 1/2	3 13/16
165	-6 3/4	10 5/16	3 5/8	-6 3/4	10 9/16	3 13/16	-6 7/8	11	4 3/16
180	2 13/16	1 3/16	3 15/16	2 7/8	1 5/16	4 1/8	3	1 9/16	4 1/2

3/8 in. OD, 56 mm (2.20 in.) Radius Bend Shoe

Bend Angle Degrees	Carbon Steel and Stainless Steel Tubing		
	Steel Bend Shoe		
	Bend Allowance	Bend Deduction	Bend Length
15	5/16	5/16	11/16
22 1/2	7/16	1/2	15/16
30	5/8	5/8	1 1/4
45	7/8	1	1 7/8
60	1 1/16	1 3/8	2 7/16
75	1 1/4	1 13/16	3 1/16
90	1 5/16	2 3/8	3 5/8
105	1 3/16	3 1/16	4 1/4
120	3/4	4 1/16	4 13/16
135	-3/16	5 5/8	5 7/16
150	-2 11/16	8 11/16	6
165	-11	17 5/8	6 5/8
180	4 7/8	2 3/8	7 3/16

3/8 in. OD, IPT Series, 56 mm (2.20 in.) Radius Bend Shoe with Effective Bend Radius of 2.44 in.

Bend Angle Degrees	IPT Series Medium- and High-Pressure Tubing		
	Steel Bend Shoe		
	Bend Allowance	Bend Deduction	Bend Length
15	7/16	7/16	13/16
22 1/2	9/16	9/16	1 1/8
30	11/16	3/4	1 7/16
45	1	1 1/8	2 1/8
60	1 1/4	1 1/2	2 3/4
75	1 3/8	1 15/16	3 3/8
90	1 1/2	2 9/16	4
105	1 3/8	3 5/16	4 5/8
120	15/16	4 3/8	5 1/4
135	-1/8	6	5 15/16
150	-2 11/16	9 1/4	6 9/16
165	-11 1/2	18 11/16	7 3/16
180	5 5/16	2 9/16	7 13/16

Fractional Tubing continued

Dimensions are in inches.

1/2 in. OD, 36 mm (1.42 in.) Radius Bend Shoe

Bend Angle Degrees	Carbon Steel and Stainless Steel Tubing						Medium-Pressure Tubing		
	Aluminum Bend Shoe			Steel Bend Shoe			Steel Bend Shoe		
	Bend Allowance	Bend Deduction	Bend Length	Bend Allowance	Bend Deduction	Bend Length	Bend Allowance	Bend Deduction	Bend Length
15	-1/16	-1/16	-1/8	1/8	1/8	1/4	1/16	1/16	3/16
22 1/2	0	1/16	1/16	3/16	1/4	7/16	3/16	3/16	3/8
30	1/16	1/8	3/16	1/4	5/16	9/16	1/4	5/16	9/16
45	1/4	5/16	9/16	7/16	1/2	15/16	3/8	1/2	7/8
60	3/8	9/16	15/16	9/16	3/4	1 5/16	9/16	3/4	1 1/4
75	7/16	13/16	1 1/4	5/8	1	1 5/8	5/8	1	1 5/8
90	7/16	1 3/16	1 5/8	5/8	1 3/8	2	5/8	1 5/16	2
105	7/16	1 9/16	2	9/16	1 3/4	2 3/8	5/8	1 3/4	2 5/16
120	1/4	2 1/8	2 3/8	3/8	2 3/8	2 3/4	3/8	2 5/16	2 11/16
135	-3/8	3 1/16	2 11/16	-1/4	3 5/16	3 1/16	-1/4	3 5/16	3 1/16
150	-1 13/16	4 7/8	3 1/16	-1 3/4	5 3/16	3 7/16	-1 11/16	5 1/8	3 7/16
165	-6 15/16	10 5/16	3 7/16	-6 7/8	10 11/16	3 13/16	-6 13/16	10 5/8	3 13/16
180	2 5/8	1 3/16	3 3/4	2 13/16	1 3/8	4 1/8	2 13/16	1 5/16	4 1/8

1/2 in. OD, 56 mm (2.20 in.) Radius Bend Shoe

Bend Angle Degrees	Carbon Steel and Stainless Steel Tubing		
	Steel Bend Shoe		
	Bend Allowance	Bend Deduction	Bend Length
15	5/8	5/8	1 1/4
22 1/2	3/4	13/16	1 1/2
30	7/8	15/16	1 13/16
45	1 1/8	1 1/4	2 3/8
60	1 5/16	1 5/8	2 15/16
75	1 7/16	2 1/16	3 1/2
90	1 1/2	2 9/16	4 1/16
105	1 5/16	3 1/4	4 5/8
120	7/8	4 1/4	5 3/16
135	-1/8	5 13/16	5 3/4
150	-2 1/2	8 13/16	6 5/16
165	-10 1/2	17 5/16	6 7/8
180	4 7/8	2 9/16	7 7/16

Fractional Tubing continued

Dimensions are in inches.

9/16 in. OD, IPT Series, 82 mm (3.23 in.) Radius Bend Shoe with Effective Bend Radius of 3.47 in.

Bend Angle Degrees	IPT Series Medium- and High-Pressure Tubing		
	Steel Bend Shoe		
	Bend Allowance	Bend Deduction	Bend Length
15	7/16	7/16	7/8
22 1/2	11/16	11/16	1 3/8
30	7/8	15/16	1 13/16
45	1 1/4	1 7/16	2 11/16
60	1 5/8	2	3 5/8
75	1 7/8	2 11/16	4 1/2
90	1 15/16	3 1/2	5 7/16
105	1 13/16	4 1/2	6 5/16
120	1 3/16	6	7 1/4
135	-1/4	8 3/8	8 1/8
150	-3 15/16	12 15/16	9
165	-16 7/16	26 3/8	9 15/16
180	7 3/8	3 1/2	10 13/16

Fractional Tubing continued

Dimensions are in inches.

5/8 in. OD, 46 mm (1.81 in.) Radius Bend Shoe

Bend Angle Degrees	Carbon Steel and Stainless Steel Tubing					
	Aluminum Bend Shoe			Steel Bend Shoe		
	Bend Allowance	Bend Deduction	Bend Length	Bend Allowance	Bend Deduction	Bend Length
15	3/16	3/16	3/8	3/8	3/8	3/4
22 1/2	5/16	5/16	5/8	1/2	1/2	1
30	3/8	7/16	7/8	9/16	5/8	1 3/16
45	9/16	11/16	1 5/16	3/4	7/8	1 11/16
60	3/4	1	1 3/4	15/16	1 3/16	2 1/8
75	7/8	1 3/8	2 1/4	1 1/16	1 9/16	2 9/16
90	15/16	1 3/4	2 11/16	1 1/16	1 15/16	3
105	13/16	2 5/16	3 1/8	15/16	2 9/16	3 1/2
120	1/2	3 1/16	3 5/8	9/16	3 5/16	3 15/16
135	-1/4	4 5/16	4 1/16	-3/16	4 5/8	4 3/8
150	-2 3/16	6 11/16	4 1/2	-2 3/16	7	4 13/16
165	-8 11/16	13 11/16	5	-8 3/4	14 1/16	5 5/16
180	3 11/16	1 3/4	5 7/16	3 13/16	1 15/16	5 3/4

3/4 in. OD, 56 mm (2.20 in.) Radius Bend Shoe

Bend Angle Degrees	Carbon Steel and Stainless Steel Tubing					
	Aluminum Bend Shoe			Steel Bend Shoe		
	Bend Allowance	Bend Deduction	Bend Length	Bend Allowance	Bend Deduction	Bend Length
15	3/8	3/8	3/4	1/2	9/16	1 1/16
22 1/2	1/2	9/16	1	5/8	11/16	1 5/16
30	5/8	11/16	1 5/16	3/4	13/16	1 5/8
45	7/8	1	1 7/8	1	1 3/16	2 3/16
60	1 1/16	1 3/8	2 7/16	1 1/4	1 1/2	2 3/4
75	1 3/16	1 13/16	2 15/16	1 3/8	1 15/16	3 5/16
90	1 1/4	2 5/16	3 1/2	1 7/16	2 7/16	3 7/8
105	1 1/8	3	4 1/16	1 1/4	3 3/16	4 7/16
120	11/16	3 15/16	4 5/8	13/16	4 1/8	5
135	-1/4	5 7/16	5 3/16	-1/8	5 11/16	5 9/16
150	-2 5/8	8 3/8	5 3/4	-2 1/2	8 5/8	6 1/8
165	-10 9/16	16 7/8	6 5/16	-10 1/2	17 3/16	6 11/16
180	4 9/16	2 5/16	6 7/8	4 3/4	2 7/16	7 1/4

Fractional Tubing continued

Dimensions are in inches.

7/8 in. OD, 67 mm (2.64 in.) Radius Bend Shoe

Bend Angle Degrees	Carbon Steel and Stainless Steel Tubing					
	Aluminum Bend Shoe			Steel Bend Shoe		
	Bend Allowance	Bend Deduction	Bend Length	Bend Allowance	Bend Deduction	Bend Length
15	1/4	1/4	1/2	0	0	0
22 1/2	3/8	7/16	13/16	1/8	3/16	5/16
30	9/16	5/8	1 3/16	5/16	3/8	11/16
45	7/8	1	1 7/8	9/16	3/4	1 5/16
60	1 1/8	1 7/16	2 9/16	13/16	1 3/16	2
75	1 5/16	1 15/16	3 3/16	1	1 11/16	2 11/16
90	1 3/8	2 9/16	3 7/8	1 1/16	2 5/16	3 3/8
105	1 1/4	3 5/16	4 9/16	1	3 1/16	4 1/16
120	13/16	4 7/16	5 1/4	5/8	4 1/8	4 11/16
135	-5/16	6 1/4	5 15/16	-7/16	5 7/8	5 3/8
150	-3 1/16	9 11/16	6 5/8	-3 3/16	9 1/4	6 1/16
165	-12 9/16	19 7/8	7 5/16	-12 11/16	19 7/16	6 3/4
180	5 7/16	2 9/16	8	5 1/8	2 5/16	7 7/16

1 in. OD, 82 mm (3.23 in.) Radius Bend Shoe

Bend Angle Degrees	Carbon Steel and Stainless Steel Tubing					
	Aluminum Bend Shoe			Steel Bend Shoe		
	Bend Allowance	Bend Deduction	Bend Length	Bend Allowance	Bend Deduction	Bend Length
15	15/16	15/16	1 13/16	1/2	1/2	15/16
22 1/2	1 1/8	1 1/8	2 1/4	11/16	11/16	1 3/8
30	1 5/16	1 3/8	2 11/16	7/8	15/16	1 13/16
45	1 11/16	1 13/16	3 1/2	1 1/4	1 3/8	2 5/8
60	2	2 3/8	4 3/8	1 9/16	1 15/16	3 7/16
75	2 1/4	3	5 1/4	1 3/4	2 9/16	4 5/16
90	2 5/16	3 3/4	6 1/16	1 13/16	3 5/16	5 1/8
105	2 1/8	4 13/16	6 15/16	1 11/16	4 5/16	6
120	1 1/2	6 1/4	7 3/4	1 1/8	5 11/16	6 13/16
135	1/16	8 9/16	8 5/8	-1/4	7 7/8	7 5/8
150	-3 7/16	12 7/8	9 7/16	-3 11/16	12 3/16	8 1/2
165	-15 1/8	25 7/16	10 5/16	-15 5/16	24 5/8	9 5/16
180	7 7/16	3 3/4	11 1/8	6 7/8	3 5/16	10 1/8

Fractional Tubing continued

Dimensions are in inches.

1 1/4 in. OD, 112 mm (4.41 in.) Radius Bend Shoe

Bend Angle Degrees	Standard Tubing		
	Carbon Steel and Stainless Steel Tubing		
	Bend Allowance	Bend Deduction	Bend Length
15	13/16	7/8	1 11/16
22 1/2	1 1/16	1 3/16	2 3/16
30	1 5/16	1 7/16	2 3/4
45	1 3/4	2 1/8	3 7/8
60	2 1/8	2 13/16	5
75	2 7/16	3 11/16	6 1/16
90	2 1/2	4 11/16	7 3/16
105	2 3/16	6 1/16	8 1/4
120	1 3/8	8	9 3/8
135	-9/16	11 1/16	10 1/2
150	-5 5/16	16 15/16	11 9/16
165	-21 5/16	34	12 11/16
180	9 1/8	4 11/16	13 13/16

Metric Tubing

Dimensions are in millimeters.

6 mm OD, 36 mm Radius Bend Shoe

Bend Angle Degrees	Carbon Steel and Stainless Steel Tubing					
	Aluminum Bend Shoe			Steel Bend Shoe		
	Bend Allowance	Bend Deduction	Bend Length	Bend Allowance	Bend Deduction	Bend Length
15	-1	0	-1	8	9	17
22 1/2	1	2	4	10	11	22
30	4	5	8	13	14	26
45	7	10	17	16	19	35
60	11	16	26	20	25	44
75	13	23	35	22	32	53
90	14	31	45	23	40	63
105	13	41	54	20	52	72
120	7	56	63	13	68	81
135	-8	79	72	-3	93	90
150	-45	126	81	-42	141	99
165	-174	264	90	-173	281	108
180	68	31	99	77	40	117

10 mm OD, 36 mm Radius Bend Shoe

Bend Angle Degrees	Carbon Steel and Stainless Steel Tubing					
	Aluminum Bend Shoe			Steel Bend Shoe		
	Bend Allowance	Bend Deduction	Bend Length	Bend Allowance	Bend Deduction	Bend Length
15	-1	0	-1	4	5	9
22 1/2	1	2	4	6	7	13
30	4	5	8	8	10	18
45	7	10	17	11	15	26
60	11	16	26	14	21	35
75	13	23	35	16	28	44
90	14	31	45	17	36	53
105	13	41	54	14	47	61
120	7	56	63	8	62	70
135	-8	79	72	-8	87	79
150	-45	126	81	-47	134	88
165	-174	264	90	-177	273	96
180	68	31	99	69	36	105

Metric Tubing continued

Dimensions are in millimeters.

12 mm OD, 36 mm Radius Bend Shoe

Bend Angle Degrees	Carbon Steel and Stainless Steel Tubing					
	Aluminum Bend Shoe			Steel Bend Shoe		
	Bend Allowance	Bend Deduction	Bend Length	Bend Allowance	Bend Deduction	Bend Length
15	-3	-2	-5	1	2	3
22 1/2	-1	0	0	3	4	8
30	2	3	4	5	7	12
45	5	8	13	9	12	21
60	9	14	22	12	18	30
75	11	21	31	14	25	39
90	12	29	41	15	33	48
105	11	39	50	14	43	57
120	6	53	59	8	58	66
135	-9	76	68	-7	82	75
150	-46	123	77	-45	129	84
165	-175	261	86	-175	268	93
180	66	29	95	69	33	102

14 mm OD, 46 mm Radius Bend Shoe

Bend Angle Degrees	Carbon Steel and Stainless Steel Tubing					
	Aluminum Bend Shoe			Steel Bend Shoe		
	Bend Allowance	Bend Deduction	Bend Length	Bend Allowance	Bend Deduction	Bend Length
15	5	6	11	8	9	17
22 1/2	8	9	17	11	12	23
30	11	12	23	13	15	29
45	16	19	35	18	22	40
60	20	26	47	22	30	52
75	24	35	58	25	38	63
90	25	46	70	25	49	74
105	23	59	82	22	63	86
120	15	79	94	13	84	97
135	-4	110	106	-7	116	108
150	-53	171	118	-57	177	120
165	-219	348	130	-224	355	131
180	96	46	142	94	49	143

Metric Tubing continued

Dimensions are in millimeters.

15 mm OD, 46 mm Radius Bend Shoe

Bend Angle Degrees	Carbon Steel and Stainless Steel Tubing					
	Aluminum Bend Shoe			Steel Bend Shoe		
	Bend Allowance	Bend Deduction	Bend Length	Bend Allowance	Bend Deduction	Bend Length
15	4	5	9	8	9	17
22 1/2	7	8	15	11	12	23
30	10	11	21	14	15	29
45	15	18	32	19	22	41
60	19	25	44	23	29	53
75	22	34	56	27	38	64
90	23	45	68	28	49	76
105	21	58	80	25	63	88
120	14	78	91	17	83	100
135	-6	109	103	-3	115	112
150	-54	169	115	-52	176	124
165	-220	347	127	-218	354	136
180	94	45	139	99	49	148

16 mm OD, 46 mm Radius Bend Shoe

Bend Angle Degrees	Carbon Steel and Stainless Steel Tubing					
	Aluminum Bend Shoe			Steel Bend Shoe		
	Bend Allowance	Bend Deduction	Bend Length	Bend Allowance	Bend Deduction	Bend Length
15	5	6	11	6	6	12
22 1/2	8	9	16	8	9	18
30	10	12	22	11	12	23
45	15	19	34	16	19	35
60	19	26	46	20	27	47
75	22	35	57	23	35	59
90	23	46	69	24	46	70
105	21	59	80	22	60	82
120	13	79	92	14	80	94
135	-7	110	104	-6	111	105
150	-56	171	115	-55	172	117
165	-222	348	127	-221	349	129
180	93	46	139	95	46	141

Metric Tubing continued

Dimensions are in millimeters.

18 mm OD, 56 mm Radius Bend Shoe

Bend Angle Degrees	Carbon Steel and Stainless Steel Tubing					
	Aluminum Bend Shoe			Steel Bend Shoe		
	Bend Allowance	Bend Deduction	Bend Length	Bend Allowance	Bend Deduction	Bend Length
15	8	8	16	14	14	28
22 1/2	11	12	23	17	18	35
30	14	16	30	20	22	42
45	20	24	44	27	30	57
60	25	33	58	32	39	71
75	28	44	72	35	50	85
90	29	57	86	36	63	99
105	26	74	101	33	81	114
120	16	98	115	22	106	128
135	-8	137	129	-3	146	142
150	-68	211	143	-64	221	156
165	-270	427	157	-268	438	171
180	114	57	171	122	63	185

20 mm OD, 67 mm Radius Bend Shoe

Bend Angle Degrees	Carbon Steel and Stainless Steel Tubing					
	Aluminum Bend Shoe			Steel Bend Shoe		
	Bend Allowance	Bend Deduction	Bend Length	Bend Allowance	Bend Deduction	Bend Length
15	3	4	7	1	2	3
22 1/2	7	8	15	5	6	12
30	11	13	24	9	11	20
45	18	23	41	17	21	38
60	24	34	57	23	32	55
75	28	46	74	28	44	72
90	29	62	91	29	60	89
105	27	81	108	27	79	106
120	16	109	125	17	107	124
135	-12	154	142	-10	151	141
150	-83	242	159	-80	238	158
165	-324	500	176	-321	496	175
180	130	62	192	132	60	192

Metric Tubing continued

Dimensions are in millimeters.

22 mm OD, 67 mm Radius Bend Shoe

Bend Angle Degrees	Carbon Steel and Stainless Steel Tubing					
	Aluminum Bend Shoe			Steel Bend Shoe		
	Bend Allowance	Bend Deduction	Bend Length	Bend Allowance	Bend Deduction	Bend Length
15	9	10	19	7	7	14
22 1/2	13	14	27	11	12	23
30	17	19	36	15	16	31
45	24	29	53	22	26	49
60	30	40	69	29	37	66
75	34	52	86	33	50	83
90	35	68	103	35	66	100
105	32	88	120	32	86	117
120	20	117	137	21	114	135
135	-9	163	154	-8	160	152
150	-81	252	171	-78	248	169
165	-323	511	188	-320	506	186
180	136	68	204	138	66	203

25 mm OD, 82 mm Radius Bend Shoe

Bend Angle Degrees	Carbon Steel and Stainless Steel Tubing					
	Aluminum Bend Shoe			Steel Bend Shoe		
	Bend Allowance	Bend Deduction	Bend Length	Bend Allowance	Bend Deduction	Bend Length
15	24	25	49	12	13	24
22 1/2	29	30	60	16	18	35
30	34	36	70	21	24	45
45	43	48	91	29	36	65
60	51	61	113	37	49	86
75	57	77	134	41	65	106
90	59	96	155	43	84	127
105	53	123	176	38	109	147
120	36	161	197	23	145	168
135	-1	219	218	-13	201	188
150	-90	329	239	-101	309	209
165	-388	649	260	-397	627	229
180	186	96	282	166	84	250

Metric Tubing continued

Dimensions are in millimeters.

28 mm OD, 112 mm Radius Bend Shoe

Bend Angle Degrees	Carbon Steel and Stainless Steel Tubing		
	Steel Bend Shoe		
	Bend Allowance	Bend Deduction	Bend Length
15	11	12	23
22 1/2	18	20	37
30	24	28	51
45	36	44	80
60	46	62	108
75	53	83	136
90	55	110	164
105	50	143	193
120	30	191	221
135	-17	267	249
150	-136	414	277
165	-541	846	306
180	224	110	334

30 mm OD, 112 mm Radius Bend Shoe

Bend Angle Degrees	Carbon Steel and Stainless Steel Tubing		
	Steel Bend Shoe		
	Bend Allowance	Bend Deduction	Bend Length
15	9	10	18
22 1/2	15	17	32
30	22	25	47
45	34	41	75
60	44	60	103
75	51	81	132
90	53	107	160
105	48	140	188
120	29	187	217
135	-18	263	245
150	-136	410	273
165	-540	842	302
180	223	107	330

Fractional Tubing with Metric Dimensions

Tube OD is in inches. Bend radius, bend shoe, and bend dimensions are in millimeters.

1/4 in. OD, 36 mm Radius Bend Shoe

Bend Angle Degrees	Carbon Steel and Stainless Steel Tubing						Medium-Pressure Tubing		
	Aluminum Bend Shoe			Steel Bend Shoe			Steel Bend Shoe		
	Bend Allowance	Bend Deduction	Bend Length	Bend Allowance	Bend Deduction	Bend Length	Bend Allowance	Bend Deduction	Bend Length
15	1	2	3	8	8	16	9	10	19
22 1/2	3	4	7	10	10	20	12	12	24
30	5	6	12	12	13	25	14	14	28
45	9	12	21	16	18	34	18	20	38
60	13	18	30	19	24	43	21	26	47
75	15	25	40	21	31	52	24	33	56
90	16	33	49	22	39	62	25	41	66
105	15	43	58	20	51	71	22	53	75
120	9	58	67	13	67	80	15	69	84
135	-6	82	76	-3	92	89	-1	94	93
150	-44	129	85	-42	140	98	-40	143	103
165	-174	268	95	-173	280	107	-171	283	112
180	71	33	104	77	39	117	81	41	121

1/4 in. OD, IPT Series, 36 mm Radius Bend Shoe with Effective Bend Radius of 40 mm

Bend Angle Degrees	IPT Series Medium- and High-Pressure Tubing		
	Steel Bend Shoe		
	Bend Allowance	Bend Deduction	Bend Length
15	8	8	17
22 1/2	11	11	22
30	13	14	27
45	18	20	38
60	22	26	48
75	25	34	59
90	26	43	69
105	24	56	80
120	17	74	90
135	-1	101	101
150	-43	155	111
165	-188	310	122
180	89	43	132

Fractional Tubing with Metric Dimensions

Tube OD is in inches. Bend radius, bend shoe, and bend dimensions are in millimeters.

3/8 in. OD, 36 mm Radius Bend Shoe

Bend Angle Degrees	Carbon Steel and Stainless Steel Tubing						Medium-Pressure Tubing		
	Aluminum Bend Shoe			Steel Bend Shoe			Steel Bend Shoe		
	Bend Allowance	Bend Deduction	Bend Length	Bend Allowance	Bend Deduction	Bend Length	Bend Allowance	Bend Deduction	Bend Length
15	-1	-1	-2	1	2	3	7	8	15
22 1/2	1	2	3	4	4	8	10	10	20
30	3	4	7	6	6	12	12	13	25
45	7	9	17	10	12	22	15	18	34
60	11	15	26	13	18	31	19	24	43
75	13	22	35	16	25	40	21	31	52
90	14	31	45	17	33	50	21	39	61
105	14	41	54	16	43	59	19	51	70
120	8	55	63	10	58	68	12	67	79
135	-6	79	73	-5	82	77	-4	92	88
150	-43	125	82	-43	129	87	-43	140	97
165	-173	264	91	-172	268	96	-174	280	106
180	70	31	101	73	33	105	76	39	115

3/8 in. OD, 56 mm Radius Bend Shoe

Bend Angle Degrees	Carbon Steel and Stainless Steel Tubing		
	Steel Bend Shoe		
	Bend Allowance	Bend Deduction	Bend Length
15	8	9	17
22 1/2	12	13	24
30	15	17	32
45	22	25	47
60	27	35	62
75	31	46	77
90	33	60	93
105	30	78	108
120	20	103	123
135	-5	144	138
150	-68	222	153
165	-281	450	169
180	124	60	184

3/8 in. OD, IPT Series, 56 mm Radius Bend Shoe with Effective Bend Radius of 62 mm

Bend Angle Degrees	IPT Series Medium- and High-Pressure Tubing		
	Steel Bend Shoe		
	Bend Allowance	Bend Deduction	Bend Length
15	10	11	21
22 1/2	14	15	29
30	18	19	37
45	25	28	53
60	31	38	69
75	36	50	86
90	37	64	102
105	34	84	118
120	24	111	134
135	-3	153	150
150	-69	235	166
165	-293	475	183
180	134	64	199

Fractional Tubing with Metric Dimensions continued

Tube OD is in inches. Bend radius, bend shoe, and bend dimensions are in millimeters.

1/2 in. OD, 36 mm Radius Bend Shoe

Bend Angle Degrees	Carbon Steel and Stainless Steel Tubing						Medium-Pressure Tubing		
	Aluminum Bend Shoe			Steel Bend Shoe			Steel Bend Shoe		
	Bend Allowance	Bend Deduction	Bend Length	Bend Allowance	Bend Deduction	Bend Length	Bend Allowance	Bend Deduction	Bend Length
15	-2	-2	-4	3	3	6	2	2	4
22 1/2	0	1	1	5	6	10	4	5	9
30	2	3	5	7	8	15	6	7	14
45	6	9	14	11	13	24	10	13	23
60	9	14	23	14	19	33	13	18	32
75	11	21	32	16	26	42	16	25	41
90	12	30	42	17	35	51	17	34	50
105	11	40	51	15	45	60	15	44	59
120	6	54	60	9	60	69	9	59	69
135	-9	78	69	-6	85	78	-6	84	78
150	-46	124	78	-45	132	87	-44	131	87
165	-176	262	87	-175	271	96	-174	270	96
180	66	30	96	71	35	105	72	34	105

1/2 in. OD, 56 mm Radius Bend Shoe

Bend Angle Degrees	Carbon Steel and Stainless Steel Tubing		
	Steel Bend Shoe		
	Bend Allowance	Bend Deduction	Bend Length
15	16	16	32
22 1/2	19	20	39
30	22	24	46
45	28	32	60
60	33	41	74
75	37	52	89
90	38	65	103
105	34	83	117
120	23	109	131
135	-2	148	146
150	-63	223	160
165	-267	441	174
180	124	65	189

Fractional Tubing with Metric Dimensions continued

Tube OD is in inches. Bend radius, bend shoe, and bend dimensions are in millimeters.

9/16 in. OD, IPT Series, 82 mm. Radius Bend Shoe with Effective Bend Radius of 88 mm

Bend Angle Degrees	IPT Series Medium- and High-Pressure Tubing		
	Steel Bend Shoe		
	Bend Allowance	Bend Deduction	Bend Length
15	11	12	23
22 1/2	17	18	34
30	22	24	46
45	32	36	69
60	41	51	92
75	47	68	115
90	49	88	137
105	46	115	160
120	31	152	183
135	-6	212	206
150	-99	328	229
165	-416	668	252
180	187	88	275

Fractional Tubing with Metric Dimensions continued

Tube OD is in inches. Bend radius, bend shoe, and bend dimensions are in millimeters.

5/8 in. OD, 46 mm Radius Bend Shoe

Bend Angle Degrees	Carbon Steel and Stainless Steel Tubing					
	Aluminum Bend Shoe			Steel Bend Shoe		
	Bend Allowance	Bend Deduction	Bend Length	Bend Allowance	Bend Deduction	Bend Length
15	6	6	10	9	10	20
22 1/2	8	8	16	12	13	25
30	10	12	22	15	16	31
45	15	18	33	19	23	43
60	19	26	45	23	31	54
75	22	34	57	26	39	66
90	23	45	68	27	50	77
105	21	59	80	24	65	89
120	13	79	92	15	85	100
135	-7	110	103	-5	117	112
150	-56	170	115	-55	178	123
165	-221	348	126	-222	357	135
180	93	45	138	96	50	146

3/4 in. OD, 56 mm Radius Bend Shoe

Bend Angle Degrees	Carbon Steel and Stainless Steel Tubing					
	Aluminum Bend Shoe			Steel Bend Shoe		
	Bend Allowance	Bend Deduction	Bend Length	Bend Allowance	Bend Deduction	Bend Length
15	9	10	19	13	14	27
22 1/2	12	14	26	17	18	34
30	16	17	33	20	21	41
45	22	26	47	26	30	56
60	27	35	61	31	39	70
75	30	45	75	35	49	84
90	31	58	89	36	62	98
105	28	76	104	32	80	112
120	18	100	118	21	105	127
135	-7	139	132	-4	145	141
150	-67	213	146	-64	219	155
165	-269	429	160	-267	436	169
180	116	58	174	121	62	184

Fractional Tubing with Metric Dimensions continued

Tube OD is in inches. Bend radius, bend shoe, and bend dimensions are in millimeters.

7/8 in. OD, 67 mm Radius Bend Shoe

Bend Angle Degrees	Carbon Steel and Stainless Steel Tubing					
	Aluminum Bend Shoe			Steel Bend Shoe		
	Bend Allowance	Bend Deduction	Bend Length	Bend Allowance	Bend Deduction	Bend Length
15	6	6	12	0	0	0
22 1/2	10	11	21	4	5	8
30	14	16	30	8	9	17
45	22	25	47	15	19	34
60	28	36	64	21	30	51
75	33	49	82	26	43	68
90	34	65	99	27	58	86
105	32	85	116	25	77	103
120	21	113	134	15	105	120
135	-7	158	151	-12	149	137
150	-78	246	168	-82	236	154
165	-320	505	186	-322	494	171
180	138	65	203	130	58	189

1 in. OD, 82 mm Radius Bend Shoe

Bend Angle Degrees	Carbon Steel and Stainless Steel Tubing					
	Aluminum Bend Shoe			Steel Bend Shoe		
	Bend Allowance	Bend Deduction	Bend Length	Bend Allowance	Bend Deduction	Bend Length
15	23	23	47	12	12	24
22 1/2	28	29	57	17	18	35
30	34	35	68	22	24	46
45	43	47	90	31	36	67
60	51	60	111	39	49	88
75	57	76	133	45	65	109
90	59	95	154	47	84	130
105	54	122	175	43	109	152
120	38	159	197	29	144	173
135	2	217	218	-6	200	194
150	-87	327	240	-93	309	215
165	-385	646	261	-389	626	236
180	188	95	283	174	84	258

Fractional Tubing with Metric Dimensions continued

Tube OD is in inches. Bend radius, bend shoe, and bend dimensions are in millimeters.

1 1/4 in. OD, 112 mm Radius Bend Shoe

Bend Angle Degrees	Carbon Steel and Stainless Steel Tubing		
	Steel Bend Shoe		
	Bend Allowance	Bend Deduction	Bend Length
15	20	22	42
22 1/2	27	29	56
30	33	37	70
45	45	53	98
60	54	72	126
75	61	93	154
90	63	119	182
105	56	154	210
120	35	203	238
135	-15	281	266
150	-136	430	294
165	-154	864	322
180	231	119	350

Minimum Length of Last Leg

During bending, both rollers must remain on the tube until the desired bend angle is achieved. If the length of tube is too short, the bend may not reach its desired angle or the end of the tube may be damaged.

Specifying a final leg length equal to or greater than the minimum length of last leg length in the following tables will ensure a sufficient amount of tube exists to allow the final bend to be made correctly.



Minimum Length of Last Leg Tables

Fractional Tubing

Dimensions are in inches.

Aluminum Bend Shoe

Tube OD	1/4	3/8	1/2	5/8	3/4	7/8	1	
Bend Radius	1.42	1.42	1.42	1.81	2.20	2.64	3.23	
Bend Angle, Degrees	15	2 9/16	2 1/2	2 11/16	3 1/2	4 1/4	3 11/16	4 11/16
	22 1/2	2 11/16	2 5/8	2 13/16	3 5/8	4 7/16	3 7/8	4 7/8
	30	2 3/4	2 3/4	2 7/8	3 3/4	4 9/16	4 1/16	5 1/8
	45	2 15/16	2 15/16	3 1/16	4	4 7/8	4 7/16	5 9/16
	60	3 3/16	3 3/16	3 5/16	4 5/16	5 1/4	4 7/8	6 1/8
	75	3 7/16	3 7/16	3 9/16	4 11/16	5 11/16	5 3/8	6 3/4
	90	3 13/16	3 3/4	3 15/16	5 1/16	6 3/16	6	7 1/2
	105	4 3/16	4 3/16	4 5/16	5 5/8	6 7/8	6 3/4	8 9/16
	120	4 13/16	4 3/4	4 7/8	6 3/8	7 13/16	7 7/8	10
	135	5 3/4	5 11/16	5 13/16	7 5/8	9 5/16	9 11/16	12 5/16
	150	7 9/16	7 1/2	7 5/8	10	12 1/4	13 1/8	16 5/8
165	13 1/16	12 15/16	13 1/16	17	20 3/4	23 5/16	29 3/16	
180	3 13/16	3 3/4	3 15/16	5 1/16	6 3/16	6	7 1/2	

Steel Bend Shoe

Tube OD	1/4	1/4 Medium Pressure	1/4 IPT Series	3/8	3/8 Medium Pressure	3/8	3/8 IPT Series	1/2	1/2 Medium Pressure	1/2	
Bend Radius	1.42	1.42	1.42	1.42	1.42	2.20	2.20	1.42	1.42	2.20	
Bend Angle, Degrees	15	3 7/16	3 1/2	3 7/16	3 5/8	3 1/2	4 1/8	4	3 3/8	3 5/16	4 1/4
	22 1/2	3 9/16	3 5/8	3 9/16	3 3/4	3 5/8	4 5/16	4 1/8	3 1/2	3 7/16	4 7/16
	30	3 5/8	3 11/16	3 11/16	3 13/16	3 11/16	4 7/16	4 5/16	3 9/16	3 9/16	4 9/16
	45	3 13/16	3 7/8	3 15/16	4	3 7/8	4 13/16	4 11/16	3 3/4	3 3/4	4 7/8
	60	4 1/16	4 1/8	4 3/16	4 1/4	4 1/8	5 3/16	5 1/16	4	4	5 1/4
	75	4 5/16	4 3/8	4 1/2	4 1/2	4 3/8	5 5/8	5 1/2	4 1/4	4 1/4	5 11/16
	90	4 11/16	4 3/4	4 7/8	4 7/8	4 3/4	6 3/16	6 1/8	4 5/8	4 9/16	6 3/16
	105	5 1/8	5 3/16	5 3/8	5 1/4	5 3/16	6 7/8	6 7/8	5	5	6 7/8
	120	5 3/4	5 13/16	6 1/16	5 7/8	5 13/16	7 7/8	7 15/16	5 5/8	5 9/16	7 7/8
	135	6 3/4	6 13/16	7 3/16	6 13/16	6 13/16	9 7/16	9 9/16	6 9/16	6 9/16	9 7/16
	150	8 5/8	8 3/4	9 5/16	8 5/8	8 11/16	12 1/2	12 13/16	8 7/16	8 3/8	12 7/16
165	14 1/8	14 1/4	15 7/16	14 1/8	14 3/16	21 7/16	22 1/4	13 15/16	13 7/8	20 15/16	
180	4 11/16	4 3/4	4 7/8	4 7/8	4 3/4	6 3/16	6 1/8	4 5/8	4 9/16	6 3/16	

Minimum Length of Last Leg Tables

Fractional Tubing

Dimensions are in inches.

Steel Bend Shoe

Tube OD	9/16 IPT Series	5/8	3/4	7/8	1	1 1/4	
Bend Radius	3.23	1.81	2.20	2.64	3.23	4.41	
Bend Angle, Degrees	15	5	3 11/16	4 5/16	4 7/16	5 1/4	5 3/4
	22 1/2	5 1/4	3 13/16	4 7/16	4 5/8	5 7/16	6 1/16
	30	5 7/16	3 15/16	4 9/16	4 13/16	5 11/16	6 5/16
	45	5 15/16	4 3/16	4 15/16	5 3/16	6 1/8	7
	60	6 9/16	4 1/2	5 1/4	5 5/8	6 11/16	7 11/16
	75	7 3/16	4 7/8	5 11/16	6 1/8	7 5/16	8 9/16
	90	8	5 1/4	6 3/16	6 3/4	8 1/16	9 9/16
	105	9 1/16	5 7/8	6 15/16	7 1/2	9 1/16	10 15/16
	120	10 9/16	6 5/8	7 7/8	8 9/16	10 7/16	12 7/8
	135	12 7/8	7 15/16	9 7/16	10 5/16	12 5/8	15 15/16
	150	17 1/2	10 5/16	12 3/8	13 11/16	16 15/16	21 13/16
165	30 7/8	17 3/8	20 15/16	23 7/8	29 3/8	38 7/8	
180	8	5 1/4	6 3/16	6 3/4	8 1/16	9 9/16	

Metric Tubing

Dimensions are in millimeters.

Aluminum Bend Shoe

Tube OD	6	10	12	14	15	16	18	20	22	25	
Bend Radius	36	36	36	46	46	46	56	67	67	82	
Bend Angle, Degrees	15	63	65	69	88	87	89	102	89	96	122
	22 1/2	65	67	71	91	90	92	106	93	100	128
	30	68	70	74	94	93	95	110	98	105	133
	45	73	75	79	101	100	102	118	108	115	145
	60	79	81	85	108	108	109	127	119	126	159
	75	86	88	92	117	116	118	138	131	138	174
	90	94	96	100	128	127	129	151	147	154	194
	105	104	106	110	141	141	142	168	166	174	221
	120	119	121	124	161	160	162	192	194	203	258
	135	142	144	147	192	191	193	231	239	249	316
	150	189	191	194	253	252	254	305	327	338	427
165	327	329	332	430	429	431	521	585	597	746	
180	94	96	100	128	127	129	151	147	154	194	

Steel Bend Shoe

Tube OD	6	10	12	14	15	16	18	20	22	25	28	30	
Bend Radius	36	36	36	46	46	46	56	67	67	82	112	112	
Bend Angle, Degrees	15	87	80	83	91	91	89	108	112	118	130	141	140
	22 1/2	89	82	85	94	94	92	112	116	123	136	149	147
	30	92	85	88	97	97	95	116	121	127	141	157	155
	45	97	90	93	104	104	102	124	131	137	153	173	171
	60	103	96	99	112	112	110	133	142	148	167	191	190
	75	110	103	106	120	120	118	144	154	161	182	212	211
	90	118	111	114	131	131	129	157	170	177	202	239	237
	105	130	122	124	145	145	143	175	189	197	227	272	270
	120	146	137	139	166	166	163	200	217	225	262	320	317
	135	171	162	163	198	197	194	240	261	271	318	396	393
	150	219	209	210	259	258	255	315	348	359	427	543	540
165	359	348	349	437	436	432	532	606	617	744	975	972	
180	118	111	114	131	131	129	157	170	177	202	239	237	

Minimum Length of Last Leg Tables

Fractional Tubing with Metric Dimensions

Tube OD is in inches. Bend radius and length are in millimeters.

Aluminum Bend Shoe

Tube OD	1/4	3/8	1/2	5/8	3/4	7/8	1	
Bend Radius	36	36	36	46	56	67	82	
Bend Angle, Degrees	15	65	64	69	89	108	94	119
	22 1/2	67	66	71	92	112	98	125
	30	70	69	74	95	116	103	130
	45	75	74	79	102	124	112	142
	60	81	80	85	110	133	123	156
	75	88	87	92	118	144	136	171
	90	96	95	100	129	157	152	190
	105	107	105	110	143	174	172	217
	120	121	120	124	163	199	200	255
	135	146	144	148	194	237	245	313
	150	193	190	194	254	311	334	423
	165	332	329	333	432	528	592	742
180	96	95	100	129	157	152	190	

Steel Bend Shoe

Tube OD	1/4	1/4 Medium Pressure	1/4 IPT Series	3/8	3/8 Medium Pressure	3/8	3/8 IPT Series	1/2	1/2 Medium Pressure	1/2
Bend Radius	36	36	36	36	36	56	56	36	36	56
Bend Angle, Degrees	15	87	89	88	92	89	105	101	85	108
	22 1/2	90	91	90	95	91	109	105	88	112
	30	92	94	93	97	94	113	110	90	116
	45	97	99	99	103	99	122	119	96	124
	60	103	105	105	108	105	132	129	102	133
	75	110	112	113	115	112	143	141	108	144
	90	119	120	122	124	120	157	155	117	157
	105	130	132	135	134	132	175	174	128	175
	120	146	148	153	149	148	200	201	143	201
	135	171	174	181	173	173	240	244	167	241
	150	219	222	234	220	221	318	326	214	316
	165	359	362	389	359	361	546	566	354	534
180	119	120	122	124	120	157	155	117	157	

Steel Bend Shoe

Tube OD	9/16 IPT Series	5/8	3/4	7/8	1	1 1/4	
Bend Radius	82	46	56	67	82	112	
Bend Angle, Degrees	15	127	94	109	113	133	146
	22 1/2	133	97	113	118	139	153
	30	139	100	117	122	144	161
	45	152	107	125	132	156	177
	60	166	115	134	143	170	196
	75	183	123	145	156	185	217
	90	203	134	158	172	204	243
	105	230	149	176	190	229	278
	120	268	169	201	218	265	327
	135	328	201	240	262	321	405
	150	444	262	315	349	429	554
	165	784	441	532	607	746	988
180	203	134	158	172	204	243	

Maintenance

All Models

Using the supplied grease gun, grease the two points on the upper gearbox of the bender after every 24 hours of operation.

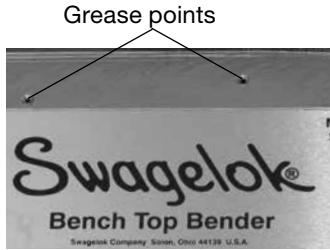

The grease must be a high-grade, multipurpose grease meeting Castrol® Molub-Alloy-860/220-1 ES or Tribol 4020/220-1 specifications.

Electric bender motor brush replacements are available for use in the field. Any other repairs to the electric or manual tube bender are to be made by a Swagelok authorized service center. Swagelok reserves the right not to make repairs in situations where the bender has been altered.

Electric Models

Inspect components for wear or damage periodically.

Motor Brush Inspection, Removal, and Replacement

The motor brushes should be inspected for wear after every 800 hours of operation, or every six months, and replaced when their length is 1/4 in. (6.4 mm) or less.

⚠ WARNING

Remove unit from power source.

⚠ CAUTION

The motor brushes are under spring tension.

⚠ CAUTION

Serious damage may occur to the motor if brushes are not replaced when worn.

1. Turn the bender over. Remove the four **socket-head cap screws** using a 5 mm hex key.

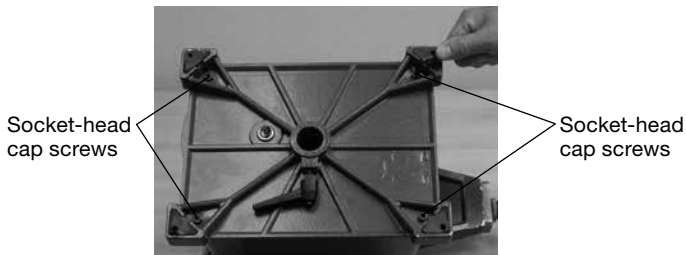

2. Remove the bottom cover.

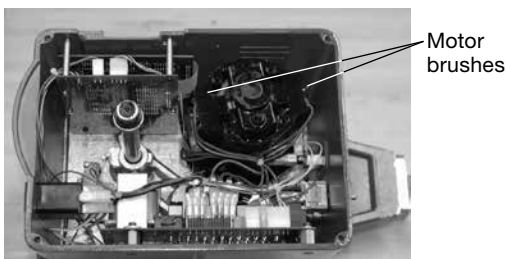

3. Using a flat screwdriver or a similar tool, rotate the **spring** away from the **motor brush** and remove the motor brush from the housing.

Note: Complete replacement of one brush, then replace the second brush.



4. Inspect the brushes for wear. Replace when the length is 1/4 in. (6.4 mm) or less.

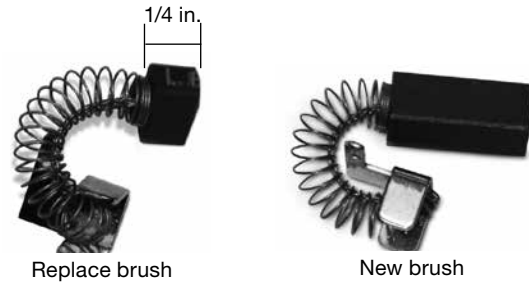

5. Reverse steps 1 through 3 to install the new motor brush. Ensure that the brush spring is secured properly in the housing.

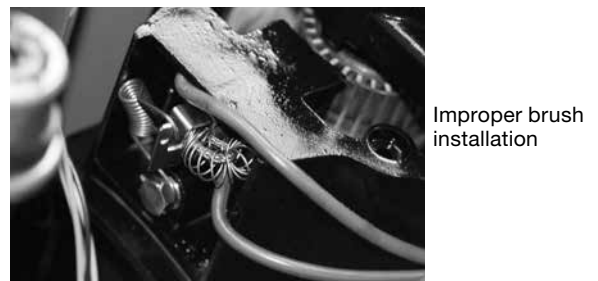

Replacement Parts

Tube Bender Components

Description	Ordering Number	Qty
Metal box with trays (manual model)	MS-BTB-CC-M	1
Metal box with trays (electric model)	MS-BTB-CC-E	1
Roller bracket ^①	MS-BTB-RS	1
G pin	16685	1
D pin	16686	1
Roller-bracket lever	MS-BTB-RAH	1
Support bracket	MS-BTB-B-SB	1
Hand crank (manual models only)	MS-BTB-HC	1
Grease gun	MS-BTB-A-GG	1
Power cord (electric models only)	MS-BTB-CORD- ^②	1
Motor brushes (electric models only)	16750	1 ^③
Tooling kit carrying case (aluminum bend shoes only)	MS-BTT-CC	1



**MS-BTB-M
Basic Manual
Model**



**MS-BTB-1 or
MS-BTB-2
Basic Electric
Model**

^① Does not include pin and pivot.

^② See *Tubing Tools and Accessories*, MS-01-179, for country and voltage designators.

^③ Order in quantities of 2.

Tooling Sets

Description	Ordering Number	
	Fractional (1/2 to 1 in.)	Metric (12 to 25 mm)
Bend shoe set	MS-BTT-B-FSET	MS-BTT-B-MSET
Guide/deformation rollers set	MS-BTT-R-FSET	MS-BTT-R-MSET
Bend shoes and guide/deformation rollers kit	MS-BTT-K-F	MS-BTT-K-M
Bend shoes and guide/deformation rollers kit with carrying case	MS-BTT-K-F-CASE	MS-BTT-K-M-CASE

Fractional set sizes: 1/2, 5/8, 3/4, 7/8, and 1 in.

Metric set sizes: 12, 16, 18, 20, 22, and 25 mm.

Individual Tools Ordering Information

- Select a basic ordering number
Example: **MS-BTT-B-XX**
- Replace **XX** with a size designator.
Example: **MS-BTT-B-8**

Description	Fractional and Metric Sizes Basic Ordering Number
G roller	MS-BTT-R-XXG
D roller	MS-BTT-R-XXD
Bend shoe and guide/ deformation roller set	MS-BTT-K-XX (aluminum)
	MS-BTT-K-SXX (steel)

Fractional Size in.	Size Designator
1/4	4
3/8	6
1/2	8
9/16	9
5/8	10
3/4	12
7/8	14
1	16
1 1/4	20

Metric Size mm	Size Designator
6	6M
10	10M
12	12M
14	14M
15	15M
16	16M
18	18M
20	20M
22	22M
25	25M
28	28M
30	30M

Replacement Parts continued

Bend Shoe Ordering Information

Material	Fractional and Metric Sizes Basic Ordering Number
Aluminum	MS-BTT-B-XX ^①
Steel	MS-BTT-B-SXX ^①

① The following sizes require an additional designator be added to the basic ordering number:

Size	Designator
6 mm	-R36
10 mm	-R36
14 mm	-R46
15 mm	-R46
3/8 in. OD, 56 mm bend radius (steel only)	-S6-R56
1/2 in. OD, 56 mm bend radius (steel only)	-R56
9/16 in. OD, 82 mm bend radius (steel only)	-S9-82
1 1/4 in. OD, 112 mm bend radius (steel only)	-R112

Example: MS-BTT-B-10M-R36

Steel bend shoes are required for bending the following:

Tube Material	Tube OD	Wall Thickness
Carbon steel, stainless steel	1 in.	> 0.095 in.
Carbon steel, stainless steel	1 1/4 in.	All
Carbon steel, stainless steel	25 mm	> 2.4 mm
Carbon steel, stainless steel	28 mm	All
Carbon steel, stainless steel	30 mm	All
1/8 hard stainless steel, alloy 2507, alloy 625	All	All
IPT series medium- and high- pressure stainless steel	1/4, 3/8, 9/16	All

Accessories
Manual Model



MS-BTB-A-TC

Torque Clutch:

Allows 1/2 in. electric or pneumatic drill motor to be used in place of hand crank on manual bender.



MS-BTB-A-SA

Support Arm:

Must be used with torque clutch to support drill motor.

Electric Model



MS-BTB-A-FS

Foot Switch

Operates the electric bender in place of the toggle switch.

All Models



MS-BTB-A-TP

Collapsible Tripod

Description	Ordering Number
Tripod	MS-BTB-A-TP
Torque clutch	MS-BTB-A-TC
Support arm	MS-BTB-A-SA
Foot pedal	MS-BTB-A-FS





Manual bender using torque clutch, support arm, and collapsible tripod with customer electric drill motor.

⚠ CAUTION
Torque clutch and support arm must be used together for safe operation.

Achieving Quality Bends

- Always use the correct size bend shoes and rollers for the tube you are bending.
- Make sure the correct radius bend shoe is used for the wall thickness of the tube that you are bending. Tube with less than the recommended wall thickness can be bent properly using a bend shoe with a larger radius.
- The pressure between the bend shoe and the rollers must be correct. You must apply sufficient pressure to avoid wrinkles on the inside bend of the tube, but too much will leave heavy roller forming marks on the back of the bend.

Troubleshooting

Problem	Cause	Solution
Wrinkles occur on inside surface of the bend. 	Forming pressure is insufficient.	Apply more pressure on the tube by turning the roller knob clockwise, then recalibrate.
	Bend shoe is contacting roller.	Bend shoe may be worn. Rollers or bend shoe may be the wrong size for the tube.
	Bend shoe radius may be too small.	Change to a larger-radius bend shoe.
Excessive tube deformation occurs on back surface of the bend	Forming pressure is excessive.	Reduce forming pressure by turning the roller knob counterclockwise, then recalibrate.
Bend angle is not consistent from bend to bend.	Roller knob has been rotated between bends.	Do not rotate the roller knob after Setup is completed.
Tube ovality is not acceptable. 	Forming pressure is either too high or too low.	Adjust the pressure to achieve proper results by turning the roller adjustment knob.
		Check bend shoe for proper size.
		Check bend shoe for excessive wear.
Tube kinks. 	Excessive gap between the clamp arm and rollers.	Bend with gap of approximately 3/8 in. or 10 mm between clamp arm and rollers.
Machine fails to bend tube; overload indicator illuminates. (electric model only)	Tube wall thickness or hardness is beyond the capacity of the machine.	Use suitable material for proper machine operation.
Machine makes excessive noise.	Tube wall thickness is beyond the capacity of the machine.	Use suitable material for proper machine operation.
	Gearbox requires lubrication.	Lubricate gearbox.
Both rollers do not remain on tube or end of tube is damaged during last bend.	Last leg of bend is too short	See Minimum Length of Last Leg

Warranty Information

Swagelok products are backed by The Swagelok Limited Lifetime Warranty. For a copy, visit swagelok.com or contact your authorized Swagelok representative.