

# Swagelok® VCO®-Verbindungen Installationsanleitung

Körper ohne Schweißanschlüsse

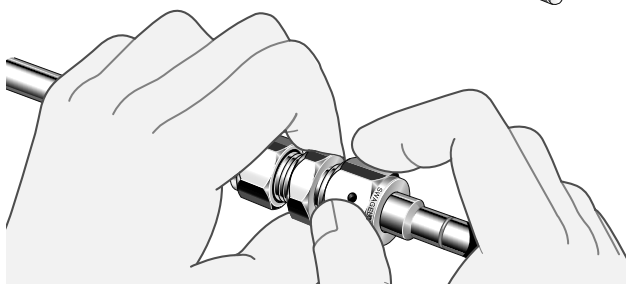

6 Fingerfest

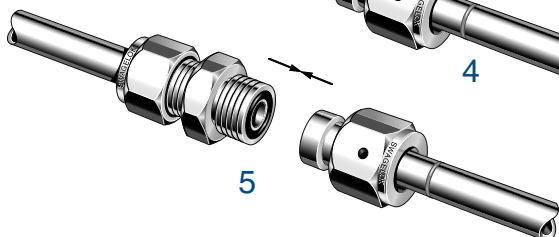
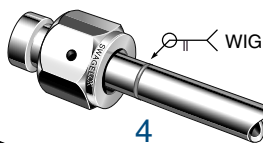
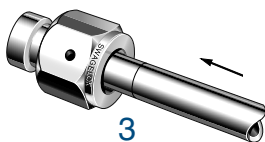
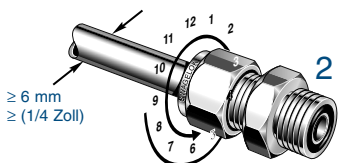
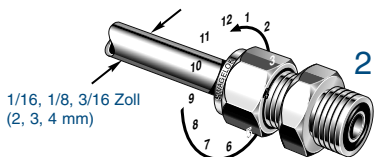
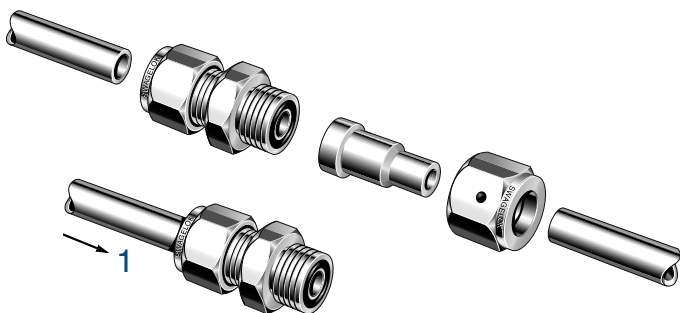
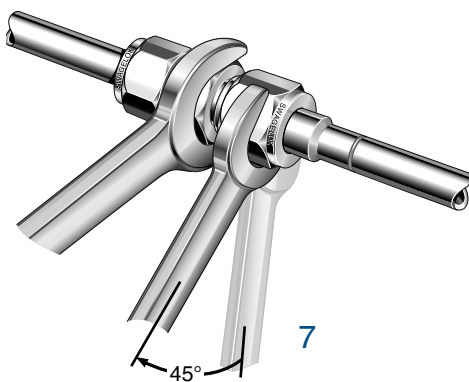

# Swagelok® VCO®-Verbindungen Installationsanleitung

## Körper mit Schweißanschlüsse

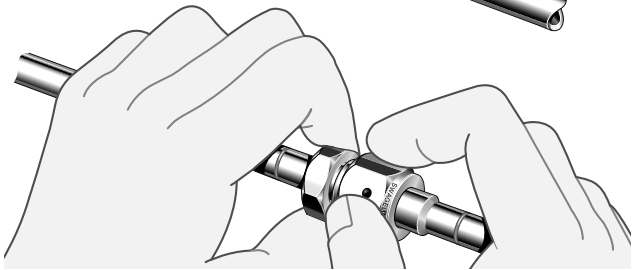
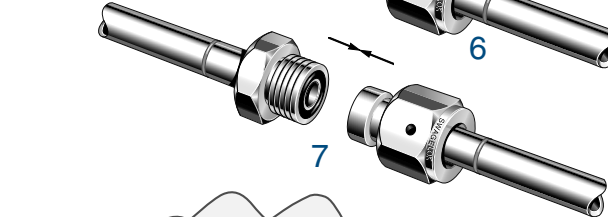
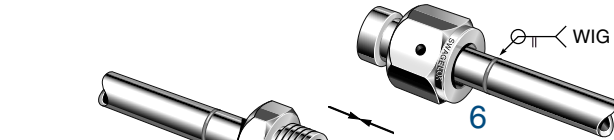
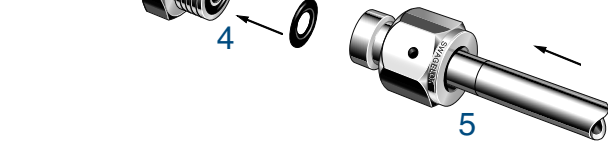
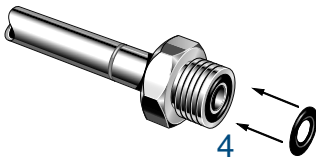
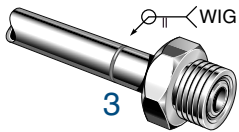
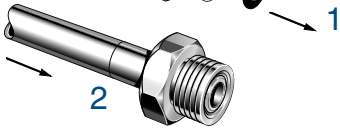
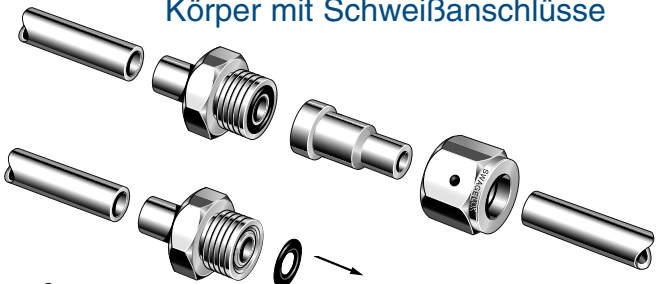

8 Fingerfest

