

VCO® O-Ring Face Seal Fittings



- 1/8 to 1 in. sizes
- 316 or 316L stainless steel
- Tube, NPT, SAE thread, and weld connections

Contents

Technical Data	2
Features	3
Testing	3
Ordering Information and Dimensions	3
Nut	
Female	3
Blind	3
Glands	
Union	4
Swagelok® Tube Fitting Connector	4
Tube Adapter	4
Weld	5
NPT Connectors	6
Male SAE/MS Connector	6

Bodies	
Unions	7
Elbow	7
Tee	7
Blind	8
Swagelok Tube Fitting Connectors	8
Swagelok Tube Fitting Elbow	8
Weld	9
NPT Connectors	9
Male NPT Elbow	10
Male SAE/MS Connector	10
Male SAE/MS Positionable Elbow	11
Options and Accessories	11
VCO Fitting Installation Instructions	11

Technical Data

Materials of Construction

Component	Material
Bodies, glands, nuts	316 SS
Automatic tube weld fittings	316L SS
O-ring, VCO bodies	Fluorocarbon FKM (70 durometer)
O-ring, SAE/MS threads	Fluorocarbon FKM (90 durometer)
Lubricant	Silicone-based

O-Ring Uniform Size Number

VCO Size in.	O-Ring Uniform Size Number
1/8 and 1/4	010
3/8 and 1/2	111
3/4	116
1	215

SAE/MS Thread Size	O-Ring Uniform Size Number
7/16-20	-904
9/16-18	-906
3/4-16	-908
1 1/16-12	-912
1 5/16-12	-916

Pressure Ratings

All ratings comply with calculations in accordance with ASME Code for Pressure Piping B31.3, Process Piping, and ASME B31.1, Power Piping.

Temperature Ratings

Temperature ratings for VCO fittings are determined by the O-ring materials.

Material	Temperature Rating °F (°C)
Fluorocarbon FKM	400 (204)
Buna N	250 (121)
PTFE	450 (232)
Perfluoroelastomer	550 (287)
Ethylene propylene	300 (148)

Features

Swagelok VCO O-ring face seal fittings are designed for rapid assembly in pipe, tube, and welded systems.

- Unique design allows easy installation where space is limited.
- No axial clearance is required.
- Sealing is accomplished with a captive O-ring in the body component.
- Assemblies can be used from high pressure to critical vacuum, within a wide range of temperatures.

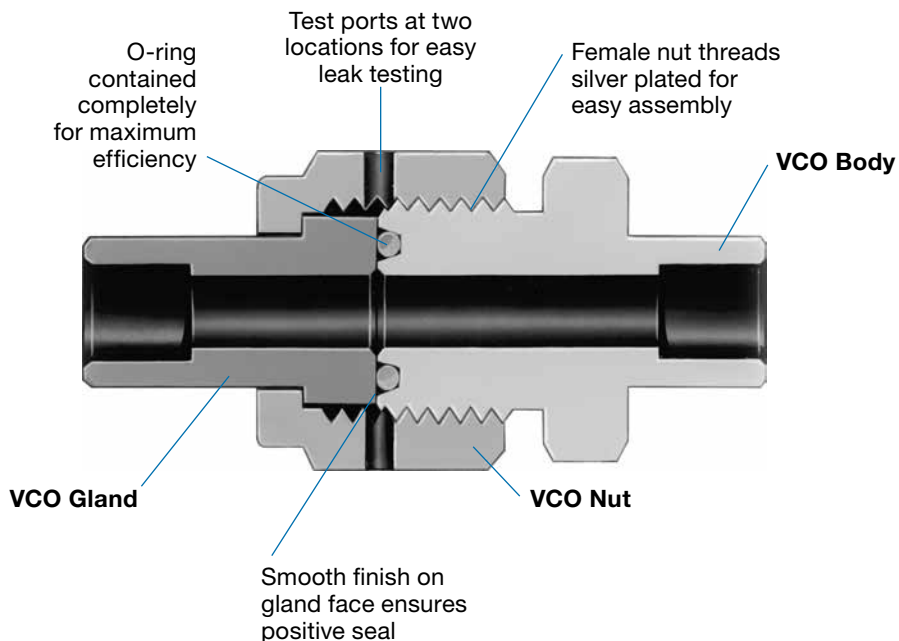

Testing

The VCO face seal fitting design has been helium leak tested to a maximum leak rate of 4×10^{-9} std cm³/s.

Ordering Information and Dimensions

- Dimensions are for reference only and are subject to change.
- The E dimension refers to the smallest nominal inside diameter of the part.

Nuts

Female

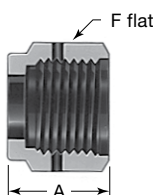

Blind

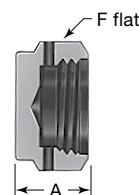

VCO Size in.	Ordering Number	Dimensions, in. (mm)	
		A	F
1/8 and 1/4	SS-4-VCO-4	0.66 (16.8)	11/16
3/8 and 1/2	SS-8-VCO-4	0.69 (17.5)	1
3/4	SS-12-VCO-4	0.81 (20.6)	1 1/2
1	SS-16-VCO-4	0.81 (20.6)	1 3/4

VCO Size in.	Ordering Number	Dimensions, in (mm)	
		A	F
1/8 and 1/4	SS-4-VCO-4-BL	0.44 (11.2)	11/16
3/8 and 1/2	SS-8-VCO-4-BL	0.56 (14.2)	1
3/4	SS-12-VCO-4-BL	0.75 (19.1)	1 1/2
1	SS-16-VCO-4-BL	0.81 (20.6)	1 3/4

Glands

Union

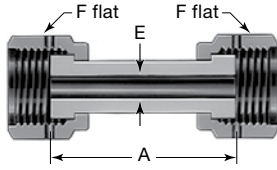

VCO Size in.	Ordering Number	Dimensions, in. (mm)			Pressure Rating psig (bar)
		A	E	F	
1/4	SS-4-WVCO-6-DF	1.42 (36.1)	0.18 (4.6)	11/16	10 200 (702)
1/2	SS-8-WVCO-6-DF	1.61 (40.9)	0.40 (10.2)	1	5 800 (399)

Swagelok Tube Fitting Connector

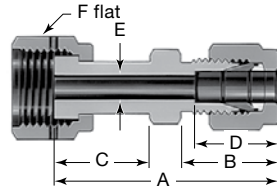

VCO Size in.	Tube OD in.	Ordering Number	Dimensions, in. (mm)						Pressure Rating psig (bar)
			A	B	C	D	E	F	
1/4	1/4	SS-4-WVCO-6-400	1.74 (44.2)	0.70 (17.8)	0.77 (19.6)	0.60 (15.2)	0.18 (4.6)	11/16	10 200 (702)
1/2	3/8	SS-8-WVCO-6-600	1.87 (47.5)	0.76 (19.3)	0.81 (20.6)	0.66 (16.8)	0.28 (7.1)	1	5 800 (399)
	1/2	SS-8-WVCO-6-810	2.01 (51.1)	0.87 (22.1)		0.90 (22.9)	0.40 (10.2)		
3/4	3/4	SS-12-WVCO-6-1210	2.14 (54.4)	0.87 (22.1)	0.94 (23.9)	0.96 (24.4)	0.62 (15.7)	1 1/2	4 000 (275)
1	1	SS-16-WVCO-6-1610	2.45 (62.2)	1.04 (26.4)	0.98 (24.9)	1.23 (31.2)	0.87 (22.1)	1 3/4	3 000 (206)

Tube Adapter

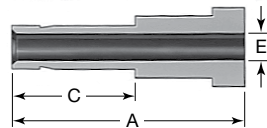

VCO Size in.	Tube OD in.	Ordering Number	Dimensions, in. (mm)			Pressure Rating psig (bar)
			A	C	E	
1/4	1/4	SS-4-VCO-3-4TA	1.31 (33.3)	0.64 (16.3)	0.17 (4.3)	10 200 (702)
1/2	3/8	SS-8-VCO-3-6TA	1.38 (35.1)	0.70 (17.8)	0.27 (6.8)	7 500 (517)
	1/2	SS-8-VCO-3-8TA	1.62 (41.1)	0.96 (24.4)	0.37 (9.3)	6 700 (461)
3/4	3/4	SS-12-VCO-3-12TA	1.80 (45.7)	1.02 (25.9)	0.58 (14.7)	5 800 (399)
1	1	SS-16-VCO-3-16TA	2.05 (52.1)	1.30 (33.0)	0.80 (20.3)	4 700 (323)

Glands

Weld

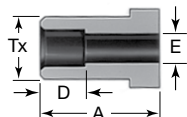

Tube Socket Weld

VCO Size in.	Tube OD in.	Ordering Number	Dimensions, in. (mm)				Pressure Rating psig (bar)
			A	D	E	Tx	
1/8	1/8	SS-2-VCO-3	0.77 (19.6)	0.10 (2.5)	0.09 (2.3)	0.38 (9.7)	15 400 (1061)
1/4	1/4	SS-4-VCO-3	0.77 (19.6)	0.28 (7.1)	0.18 (4.6)	0.38 (9.7)	6 800 (468)
3/8	3/8	SS-6-VCO-3	0.81 (20.6)	0.31 (7.9)	0.28 (7.1)	0.60 (15.2)	8 100 (558)
1/2	1/2	SS-8-VCO-3	0.81 (20.6)	0.38 (9.7)	0.40 (10.2)	0.60 (15.2)	3 000 (206)
3/4	3/4	SS-12-VCO-3	0.94 (23.9)	0.44 (11.2)	0.62 (15.7)	0.92 (23.4)	3 700 (255)
1	1	SS-16-VCO-3	0.98 (24.9)	0.62 (15.7)	0.87 (22.1)	1.19 (30.2)	3 000 (206)

Tube Socket Weld Reducing

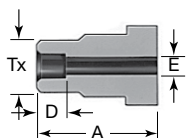

VCO Size in.	Tube OD in.	Ordering Number	Dimensions, in. (mm)				Pressure Rating psig (bar)
			A	D	E	Tx	
1/4	1/8	SS-4-VCO-3-2TSW	0.77 (19.6)	0.10 (2.5)	0.09 (2.3)	0.29 (7.4)	12 600 (868)
1/2	1/4	SS-8-VCO-3-4TSW	0.81 (20.6)	0.28 (7.1)	0.18 (4.6)	0.48 (12.2)	10 700 (737)

Male Tube Weld

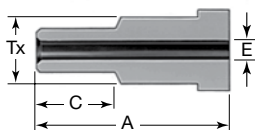

VCO Size in.	Tube OD in.	Ordering Number	Dimensions, in. (mm)				Pressure Rating psig (bar)
			A	C	E	Tx	
1/4	1/8	SS-4-VCO-3-2MTW	0.77 (19.6)	0.28 (7.1)	0.06 (1.5)	0.38 (9.7)	11 200 (771)
	1/4	SS-4-VCO-3-4MTW	1.12 (28.4)	0.41 (10.4)	0.12 (3.0)		
1/2	1/4	SS-8-VCO-3-4MTW	0.91 (23.1)	0.41 (10.4)	0.12 (3.0)	0.60 (15.2)	11 200 (771)
	3/8	SS-8-VCO-3-6MTW	0.84 (21.3)		0.23 (5.8)		8 200 (564)
	1/2	SS-8-VCO-3-8MTW	1.06 (26.9)	0.50 (12.7)	0.33 (8.4)		7 500 (516)

Automatic Tube Weld

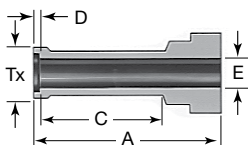

VCO Size in.	Tube OD in.	Ordering Number	Dimensions, in. (mm)					Wall Thickness	Pressure Rating psig (bar)
			A	C	D	E	Tx		
1/4	1/4	316L-4-VCO-3A	1.12 (28.4)	0.78 (19.8)	0.02 (0.51)	0.18 (4.6)	0.29 (7.4)	0.035	5100 (351)
1/2	3/8	316L-8-VCO-3A6	1.13 (28.7)	0.79 (20.0)	0.03 (0.76)	0.31 (7.9)	0.41 (10.4)	0.035	3300 (227)
	1/2	316L-8-VCO-3A	1.14 (29.0)	0.80 (20.3)	0.04 (1.0)	0.40 (10.2)	0.55 (14.0)	0.049	3500 (241)
3/4	3/4	316L-12-VCO-3A	1.20 (30.5)	0.80 (20.3)	0.04 (1.0)	0.65 (16.5)	0.80 (20.3)	0.049	2200 (151)
1	1	316L-16-VCO-3A	1.41 (35.8)	1.00 (25.4)	0.04 (1.0)	0.87 (22.1)	1.06 (26.9)	0.065	2200 (151)

Glands

NPT Connectors

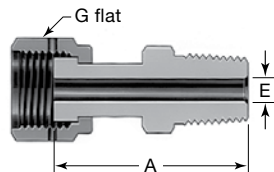

Male

VCO Size in.	NPT Size in.	Ordering Number	Dimensions, in. (mm)			Pressure Rating psig (bar)
			A	E	G	
1/4	1/4	SS-4-WVCO-1-4	1.59 (40.4)	0.18 (4.6)	11/16	9800 (675)
1/2	3/8	SS-8-WVCO-1-6	1.67 (42.4)	0.40 (10.2)	1	5600 (385)
	1/2	SS-8-WVCO-1-8	1.87 (47.5)			
3/4	3/4	SS-12-WVCO-1-12	2.03 (51.6)	0.62 (15.7)	1 1/2	3900 (268)
1	1	SS-16-WVCO-1-16	2.36 (59.9)	0.87 (22.1)	1 3/4	2900 (199)

Female

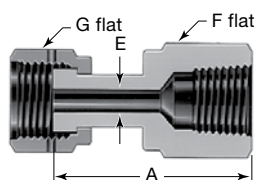

VCO Size in.	NPT Size in.	Ordering Number	Dimensions, in. (mm)				Pressure Rating psig (bar)
			A	E	F	G	
1/4	1/4	SS-4-WVCO-7-4	1.57 (39.9)	0.18 (4.6)	3/4	11/16	6600 (454)
1/2	3/8	SS-8-WVCO-7-6	1.73 (43.9)	0.40 (10.2)	7/8	1	5300 (365)
	1/2	SS-8-WVCO-7-8	1.96 (49.8)		1 1/16		4900 (337)
3/4	3/4	SS-12-WVCO-7-12	2.12 (53.8)	0.62 (15.7)	1 5/16	1 1/2	4000 (275)
1	1	SS-16-WVCO-7-16	2.29 (58.2)	0.87 (22.1)	1 5/8	1 3/4	3000 (206)

Male SAE/MS Connector

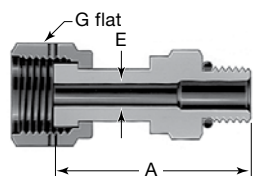

VCO Size in.	Straight Thread Size	Ordering Number	Dimensions, in. (mm)			Pressure Rating psig (bar)
			A	E	G	
1/4	7/16-20	SS-4-WVCO-1-4ST	1.54 (39.1)	0.18 (4.6)	11/16	4500 (310)
1/2	9/16-18	SS-8-WVCO-1-6ST	1.64 (41.7)	0.40 (10.2)	1	4500 (310)
	3/4-16	SS-8-WVCO-1-8ST	1.71 (43.4)			
3/4	1 1/16-12	SS-12-WVCO-1-12ST	2.07 (52.6)	0.62 (15.7)	1 1/2	3600 (248)
1	1 5/16-12	SS-16-WVCO-1-16ST	2.17 (55.1)	0.87 (22.1)	1 3/4	2900 (199)

Bodies

Unions

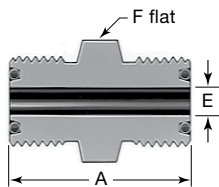

Union

VCO Size in.	Ordering Number	Dimensions, in. (mm)			Pressure Rating psig (bar)
		A	E	F	
1/4	SS-4-VCO-6	1.25 (31.8)	0.18 (4.6)	5/8	14 300 (985)
1/2	SS-8-VCO-6	1.50 (38.1)	0.40 (10.2)	15/16	11 100 (764)

Bulkhead

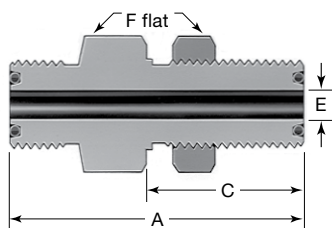

VCO Size in.	Ordering Number	Dimensions, in. (mm)					Pressure Rating psig (bar)	
		A	C	E	F	Panel Hole Drill Size		Max Panel Thickness
1/4	SS-4-VCO-61	1.88 (47.8)	1.06 (26.9)	0.18 (4.6)	3/4	37/64	0.36 (9.1)	14 300 (985)
1/2	SS-8-VCO-61	2.09 (53.1)	1.19 (30.2)	0.40 (10.2)	1 1/16	57/64	0.40 (10.2)	11 100 (764)

Reducing

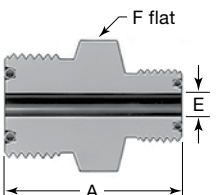

VCO Size in.	VCO Size in.	Ordering Number	Dimensions, in. (mm)			Pressure Rating psig (bar)
			A	E	F	
1/2	1/4	SS-8-VCO-6-4	1.43 (36.3)	0.18 (4.6)	15/16	11 100 (764)

Elbow

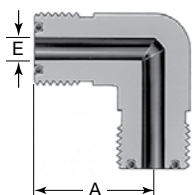

VCO Size in.	Ordering Number	Dimensions, in. (mm)		Pressure Rating psig (bar)
		A	E	
1/4	SS-4-VCO-9	0.96 (24.4)	0.18 (4.6)	14 300 (985)
1/2	SS-8-VCO-9	1.26 (32.0)	0.40 (10.2)	11 100 (764)
3/4	SS-12-VCO-9	1.48 (37.6)	0.62 (15.7)	10 900 (751)
1	SS-16-VCO-9	1.56 (39.6)	0.87 (22.1)	8 800 (606)

Tee

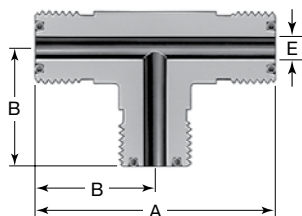

VCO Size in.	Ordering Number	Dimensions, in. (mm)			Pressure Rating psig (bar)
		A	B	E	
1/4	SS-4-VCO-T	1.92 (48.8)	0.96 (24.4)	0.18 (4.6)	14 300 (985)
1/2	SS-8-VCO-T	2.52 (64.0)	1.26 (32.0)	0.40 (10.2)	11 100 (764)
3/4	SS-12-VCO-T	2.96 (75.2)	1.48 (37.6)	0.62 (15.7)	10 900 (751)
1	SS-16-VCO-T	3.12 (79.2)	1.56 (39.6)	0.87 (22.1)	8 800 (606)

Bodies

Blind

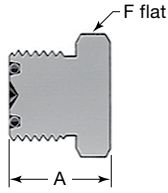

VCO Size in.	Ordering Number	Dimensions, in. (mm)	
		A	F
1/4	SS-4-VCO-1-BL	0.77 (19.6)	5/8
1/2	SS-8-VCO-1-BL	0.89 (22.6)	15/16
3/4	SS-12-VCO-1-BL	0.99 (25.1)	1 5/16
1	SS-16-VCO-1-BL	1.02 (25.9)	1 5/8

Swagelok Tube Fitting Connectors

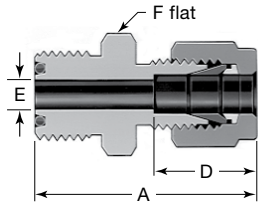

Swagelok Tube Fitting

VCO Size in.	Tube OD in.	Ordering Number	Dimensions, in. (mm)				Pressure Rating psig (bar)
			A	D	E	F	
1/4	1/8	SS-4-VCO-6-200	1.38 (35.1)	0.51 (13.0)	0.09 (2.3)	5/8	10 900 (751)
	1/4	SS-4-VCO-6-400	1.47 (37.3)	0.60 (15.2)	0.18 (4.6)		10 200 (702)
1/2	3/8	SS-8-VCO-6-600	1.65 (41.9)	0.66 (16.8)	0.28 (7.1)	15/16	7 500 (517)
	1/2	SS-8-VCO-6-810	1.78 (45.2)	0.90 (22.9)	0.40 (10.2)		6 700 (461)
3/4	3/4	SS-12-VCO-6-1210	1.86 (47.2)	0.96 (24.4)	0.62 (15.7)	1 5/16	5 800 (399)
1	1	SS-16-VCO-6-1610	2.06 (52.3)	1.23 (31.2)	0.87 (22.1)	1 5/8	4 700 (323)

Bulkhead

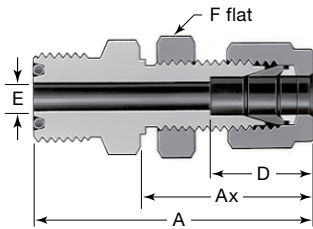

VCO Size in.	Tube OD in.	Ordering Number	Dimensions, in. (mm)					Panel Hole Drill Size	Max Panel Thickness	Pressure Rating psig (bar)
			A	Ax	D	E	F			
1/4	1/4	SS-4-VCO-A1-400	2.10 (53.3)	1.32 (33.5)	0.60 (15.2)	0.18 (4.6)	5/8	29/64	0.40 (10.2)	10 200 (702)
1/2	3/8	SS-8-VCO-A1-600	2.34 (59.4)	1.45 (36.8)	0.66 (16.8)	0.28 (7.1)	15/16	37/64	0.44 (11.2)	7 500 (517)
	1/2	SS-8-VCO-A1-810	2.55 (64.8)	1.65 (41.9)	0.90 (22.9)	0.40 (10.2)		49/64	0.50 (12.7)	6 700 (461)
3/4	3/4	SS-12-VCO-A1-1210	2.86 (72.6)	1.87 (47.5)	0.96 (24.4)	0.62 (15.7)	1 5/16	1 1/64	0.66 (16.8)	5 800 (399)
1	1	SS-16-VCO-A1-1610	3.29 (83.6)	2.26 (57.4)	1.23 (31.2)	0.87 (22.1)	1 5/8	1 21/64	0.75 (19.1)	4 700 (323)

Swagelok Tube Fitting Elbow

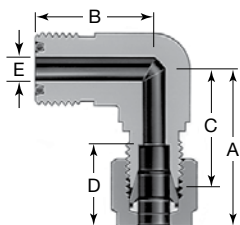

VCO Size in.	Tube OD in.	Ordering Number	Dimensions, in. (mm)					Pressure Rating psig (bar)
			A	B	C	D	E	
1/4	1/4	SS-4-VCO-9-400	1.19 (30.2)	0.96 (24.4)	0.90 (22.9)	0.60 (15.2)	0.18 (4.6)	10 200 (702)
1/2	3/8	SS-8-VCO-9-600	1.39 (35.3)	1.26 (32.0)	1.10 (27.9)	0.66 (16.8)	0.28 (7.1)	7 500 (517)
	1/2	SS-8-VCO-9-810	1.50 (38.1)			0.90 (22.9)	0.40 (10.2)	6 700 (461)
3/4	3/4	SS-12-VCO-9-1210	1.80 (45.7)	1.48 (37.6)	1.40 (35.6)	0.96 (24.4)	0.62 (15.7)	5 800 (399)
1	1	SS-16-VCO-9-1610	2.04 (51.8)	1.56 (39.6)	1.56 (39.6)	1.23 (31.2)	0.87 (22.1)	4 700 (323)

Bodies

Weld

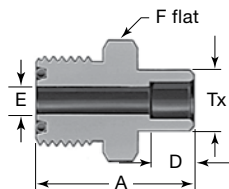

Tube Socket Weld

VCO Size in.	Tube OD in.	Ordering Number	Dimensions, in. (mm)					Pressure Rating psig (bar)
			A	D	E	F	Tx	
1/8	1/8	SS-2-VCO-1	0.88 (22.4)	0.10 (2.5)	0.09 (2.3)	5/8	0.29 (7.4)	12 600 (868)
1/4	1/4	SS-4-VCO-1	1.09 (27.7)	0.28 (7.1)	0.18 (4.6)	5/8	0.38 (9.7)	6 800 (468)
3/8	3/8	SS-6-VCO-1	1.28 (32.5)	0.31 (7.9)	0.28 (7.1)	15/16	0.60 (15.2)	8 100 (558)
1/2	1/2	SS-8-VCO-1	1.34 (34.0)	0.38 (9.7)	0.40 (10.2)	15/16	0.60 (15.2)	3 000 (206)
3/4	3/4	SS-12-VCO-1	1.50 (38.1)	0.44 (11.2)	0.62 (15.7)	1 5/16	0.92 (23.4)	3 700 (254)
1	1	SS-16-VCO-1	1.72 (43.7)	0.62 (15.7)	0.87 (22.1)	1 5/8	1.19 (30.2)	3 000 (206)

Automatic Tube Weld

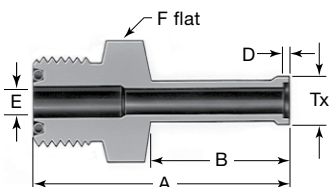

VCO Size in.	Tube OD in.	Ordering Number	Dimensions, in. (mm)							Pressure Rating psig (bar)
			A	B	D	E	F	Tx	Wall	
1/4	1/4	316L-4-VCO-1A	1.59 (40.4)	0.78 (19.8)	0.02 (0.5)	0.18 (4.6)	5/8	0.29 (7.4)	0.035	5100 (351)
1/2	3/8	316L-8-VCO-1A6	1.74 (44.2)	0.79 (20.0)	0.03 (0.8)	0.31 (7.9)	15/16	0.41 (10.4)	0.035	3300 (227)
1/2	1/2	316L-8-VCO-1A	1.75 (44.4)	0.80 (20.3)	0.04 (1.0)	0.40 (10.2)	15/16	0.55 (14.0)	0.049	3500 (241)
3/4	3/4	316L-12-VCO-1A	1.78 (45.2)	0.80 (20.3)	0.04 (1.0)	0.65 (16.5)	1 5/16	0.80 (20.3)	0.049	2200 (151)
1	1	316L-16-VCO-1A	2.03 (51.6)	1.00 (25.4)	0.04 (1.0)	0.87 (22.1)	1 5/8	1.06 (26.9)	0.065	2200 (151)

NPT Connectors

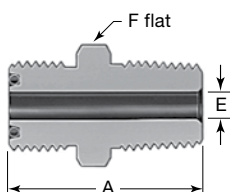

Male

VCO Size in.	NPT Size in.	Ordering Number	Dimensions, in. (mm)			Pressure Rating psig (bar)
			A	E	F	
1/4	1/8	SS-4-VCO-1-2	1.16 (29.5)	0.18 (4.6)	5/8	10 000 (689)
	1/4	SS-4-VCO-1-4	1.34 (34.0)			13 400 (923)
1/2	3/8	SS-8-VCO-1-6	1.46 (37.1)	0.38 (9.7)	15/16	7 800 (537)
	1/2	SS-8-VCO-1-8	1.65 (41.9)	0.40 (10.2)		10 000 (689)
3/4	3/4	SS-12-VCO-1-12	1.75 (44.4)	0.62 (15.7)	1 5/16	7 300 (502)
1	1	SS-16-VCO-1-16	1.97 (50.0)	0.87 (22.1)	1 5/8	5 300 (365)

Bodies

NPT Connectors

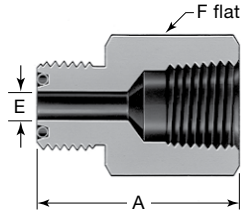

Female

VCO Size in.	NPT Size in.	Ordering Number	Dimensions, in. (mm)			Pressure Rating psig (bar)
			A	E	F	
1/4	1/8	SS-4-VCO-7-2	1.25 (31.8)	0.18 (4.6)	5/8	8400 (578)
	1/4	SS-4-VCO-7-4	1.39 (35.3)		3/4	6600 (454)
1/2	3/8	SS-8-VCO-7-6	1.57 (39.9)	0.40 (10.2)	15/16	6600 (454)
	1/2	SS-8-VCO-7-8	1.77 (45.0)		1 1/16	4900 (337)
3/4	3/4	SS-12-VCO-7-12	1.93 (49.0)	0.62 (15.7)	1 5/16	4600 (316)
1	1	SS-16-VCO-7-16	2.02 (51.3)	0.87 (22.1)	1 5/8	4400 (303)

Male Elbow

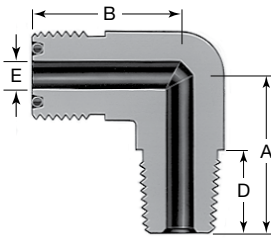

VCO Size in.	NPT Size in.	Ordering Number	Dimensions, in. (mm)				Pressure Rating psig (bar)
			A	B	D	E	
1/4	1/8	SS-4-VCO-2-2	0.87 (22.1)	0.96 (24.4)	0.38 (9.7)	0.18 (4.6)	10 000 (689)
	1/4	SS-4-VCO-2-4	1.05 (26.7)		0.56 (14.2)		8 000 (551)
1/2	3/8	SS-8-VCO-2-6	1.26 (32.0)	1.26 (32.0)	0.56 (14.2)	0.38 (9.7)	7 800 (537)
	1/2	SS-8-VCO-2-8	1.45 (36.8)		0.75 (19.1)		0.40 (10.2)
3/4	3/4	SS-12-VCO-2-12	1.67 (42.4)	1.48 (37.6)	0.75 (19.1)	0.62 (15.7)	7 300 (502)
1	1	SS-16-VCO-2-16	1.94 (49.3)	1.56 (39.6)	0.94 (23.9)	0.87 (22.0)	5 300 (365)

Male SAE/MS Connector

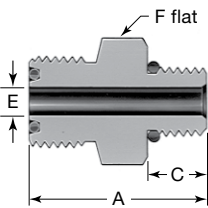

VCO Size in.	Straight Thread Size	Ordering Number	Dimensions, in. (mm)				Pressure Ratings psig (bar)	
			A	C	E	F		
1/4	7/16-20	SS-4-VCO-1-4ST	1.24 (31.5)	0.36 (9.1)	0.18 (4.6)	11/16	4500 (310)	
	9/16-18	SS-4-VCO-1-6ST	1.17 (29.7)	0.39 (9.9)				
1/2	7/16-20	SS-8-VCO-1-4ST	1.36 (34.5)	0.36 (9.1)	0.18 (4.6)	15/16	4500 (310)	
	9/16-18	SS-8-VCO-1-6ST	1.39 (35.3)	0.39 (9.9)				0.30 (7.6)
	3/4-16	SS-8-VCO-1-8ST	1.47 (37.3)	0.44 (11.2)				
3/4	1 1/16-12	SS-12-VCO-1-12ST	1.73 (43.9)	0.59 (15.0)	0.62 (15.7)	1 3/8	3600 (248)	
1	1 5/16-12	SS-16-VCO-1-16ST	1.79 (45.5)	0.59 (15.0)	0.85 (21.6)	1 5/8	2900 (199)	

Bodies

Male SAE/MS Positionable Elbow

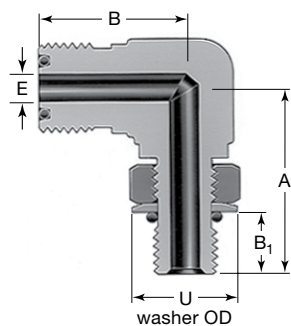

VCO Size in.	Straight Thread Size	Ordering Number	Dimensions, in. (mm)					Pressure Rating psig (bar)
			A	B	B ₁	E	U	
1/4	7/16-20	SS-4-VCO-9P-4ST	1.19 (30.2)	0.96 (24.4)	0.39 (9.9)	0.19 (4.6)	0.65 (16.5)	4500 (310)
1/2	9/16-18	SS-8-VCO-9P-6ST	1.54 (39.1)	1.33 (33.8)	0.44 (11.2)	0.30 (7.6)	0.79 (20.1)	3600 (248)
	3/4-16	SS-8-VCO-9P-8ST	1.65 (41.9)		0.50 (12.7)	0.40 (10.2)	1.01 (25.7)	
3/4	1 1/16-12	SS-12-VCO-9P-12ST	2.13 (54.1)	1.53 (38.9)	0.66 (16.8)	0.62 (15.7)	1.44 (36.6)	2900 (199)
1	1 5/16-12	SS-16-VCO-9P-16ST	2.31 (58.7)	1.72 (43.7)	0.66 (16.8)	0.87 (22.1)	1.73 (43.9)	2300 (158)

Options and Accessories

O-Ring Materials

Perfluoroelastomer, Buna N, PTFE, and ethylene propylene O-rings are available for special applications. Contact your authorized Swagelok sales and service representative for information.

VCO Fitting Installation Instructions

1 Finger-tight

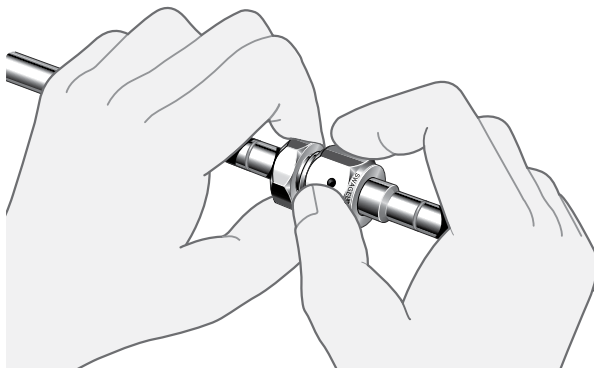

2

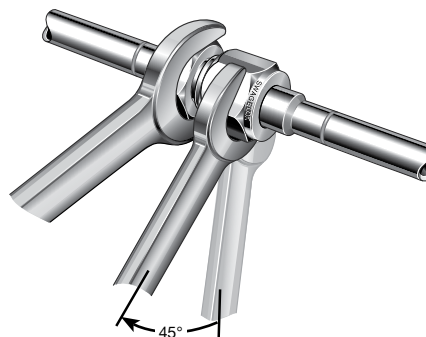

Introduction

Since 1947, Swagelok has designed, developed, and manufactured high-quality, general-purpose and specialty fluid system products to meet the evolving needs of global industries. Our focus is on understanding our customers' needs, finding timely solutions, and adding value with our products and services.

We are pleased to provide this global edition of the book-bound *Swagelok Product Catalog*, which compiles more than 100 separate product catalogs, technical bulletins, and reference documents into one convenient, easy-to-use volume. Each product catalog is up to date at the time of printing, with its revision number shown on the last page of the individual catalog. Subsequent revisions will supersede the printed version and will be posted on the Swagelok website and in the Swagelok electronic Desktop Technical Reference (eDTR) tool.

For more information, visit your Swagelok website or contact your authorized Swagelok sales and service representative.

Warranty Information

Swagelok products are backed by The Swagelok Limited Lifetime Warranty. For a copy, visit swagelok.com or contact your authorized Swagelok representative.

Safe Product Selection

When selecting a product, the total system design must be considered to ensure safe, trouble-free performance. Function, material compatibility, adequate ratings, proper installation, operation, and maintenance are the responsibilities of the system designer and user.

WARNING

Do not mix/interchange Swagelok products or components not governed by industrial design standards, including Swagelok tube fitting end connections, with those of other manufacturers.

Not all trademarks listed below apply to this catalog.
Swagelok, Cajon, Ferrule-Pak, Goop, Hinging-Collecting, IGC, Kenmac, Micro-Fit, Nupro, Snoop, Sno-Trik, SWAK, VCO, VCR, Ultra-Torr, Whitey—TM Swagelok Company
15-7 PH—TM AK Steel Corp.
AccuTrak, Beacon, Westlock—TM Tyco International Services
Atlas—TM Asahi Glass Co., Ltd.
ASCO, El-O-Matic—TM Emerson
AutoCAD—TM Autodesk, Inc.
CSA—TM Canadian Standards Association
Crastin, DuPont, Kalrez, Krytox, Teflon, Viton—TM E.I. duPont Nemours and Company
DeviceNet—TM ODVA
Dyneon, Elgiloy, TFM—TM Dyneon
Elgiloy—TM Elgiloy Specialty Metals
FM—TM FM Global
Grafoil—TM GrafTech International Holdings, Inc.
Honeywell, MICRO SWITCH—TM Honeywell
MAC—TM MAC Valves
Microsoft, Windows—TM Microsoft Corp.
NACE—TM NACE International
PH 15-7 Mo, 17-7 PH—TM AK Steel Corp
picofast—Hans Turck KG
Pillar—TM Nippon Pillar Packing Company, Ltd.
Raychem—TM Tyco Electronics Corp.
Sandvik, SAF 2507—TM Sandvik AB
Simriz—TM Freudenberg-NOK
SolidWorks—TM SolidWorks Corporation
UL—Underwriters Laboratories Inc.
Xylan—TM Whitford Corporation
© 2020 Swagelok Company