

Check Valves



C, CA, CH, CP, and CPA Series

- Working pressures up to 6000 psig (413 bar)
- Adjustable and fixed cracking pressures
- Variety of end connections
- 316 stainless steel and brass materials

Contents

Features	2	Testing	10
Technical Data	3	Cleaning and Packaging	10
Pressure-Temperature Ratings	3	Ordering Information and Dimensions	11
Cracking and Reseal Pressures	4	Options and Accessories	14
Materials of Construction	5	Maintenance Kits	15
Flow Data	7		

Features

Fixed Cracking Pressures

From 1/3 to 25 psi (0.03 to 1.8 bar)

C Series

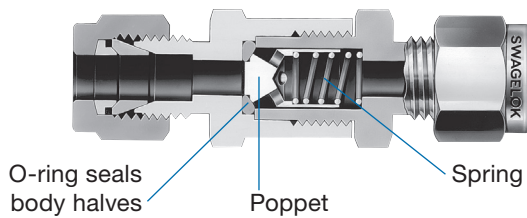

Adjustable Cracking Pressures

From 3 to 600 psi (0.21 to 41.4 bar)

CA Series

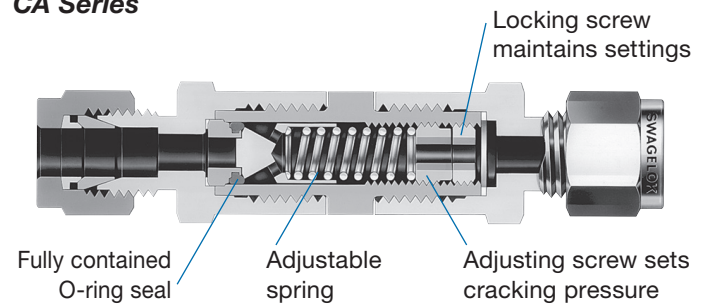

CH Series

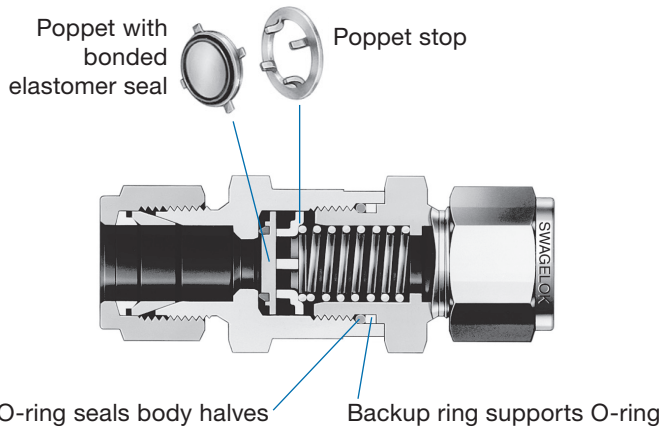

CPA Series

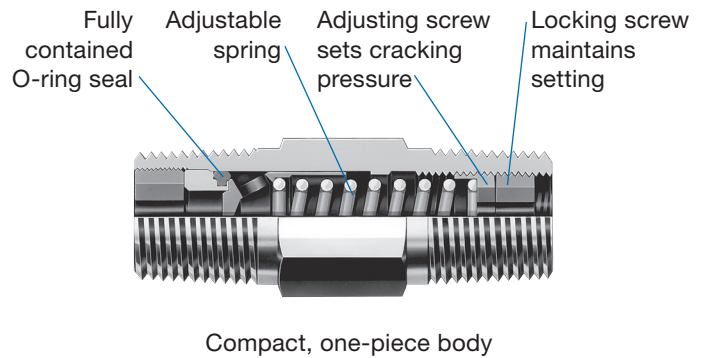

CP Series

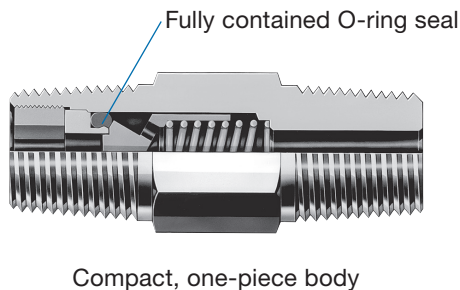

Technical Data

Cracking pressure—the inlet pressure at which the first indication of flow occurs (steady stream of bubbles).

Reseal pressure—the pressure at which there is no indication of flow.

Back pressure—the differential pressure between the inlet and outlet pressures.

⚠ For valves not actuated for a period of time, initial cracking pressure may be higher than the set cracking pressure.

Series	Maximum Flow Coefficient (C _v)	Nominal Cracking Pressure ^① psi (bar)	Maximum Back Pressure at 70°F (20°C) psig (bar)
Fixed Cracking Pressure			
2C	0.10	1/3, 1, 10 and 25 (0.03, 0.07, 0.69, and 1.8)	1000 (68.9) ^②
4C	0.47		
6C	1.47		200 (13.7)
8C	1.68		
12C, 16C	4.48	1/3, 1, 5, 10 and 25 (0.03, 0.07, 0.35, 0.69, and 1.8)	6000 (413) ^③
CH4	0.67		5000 (344) ^③
CH8	1.8		
CH16	4.7		
4CP	0.35	1/3, 1, 10 and 25 (0.03, 0.07, 0.69, and 1.8)	3000 (206)
8CP	1.20		
Adjustable Cracking Pressure			
CA	0.37	3 to 50 (0.21 to 3.5) 50 to 150 (3.5 to 10.4) 150 to 350 (10.4 to 24.2) 350 to 600 (24.2 to 41.4)	3000 (206)
4CPA	0.35		
8CPA	1.20		

For more information about pressure ratings of valves with tube fitting end connections, see Swagelok® *Tubing Data*, [MS-01-107](#).

① Other cracking pressures are available; contact your authorized Swagelok sales and service representative.

② For cracking pressure of 25 psi (1.8 bar), maximum back pressure is 3000 psig (206 bar).

③ Maximum back pressure may be limited by the end connection. See **Dimensions**, page 12.

Pressure-Temperature Ratings

C (2C, 4C, 6C, and 8C), CA, CP, and CPA Series

Ratings based on fluorocarbon FKM O-rings in 316 stainless steel valves and Buna N O-rings in brass valves.

Material	316 SS	Brass
Temperature, °F (°C)	Working Pressure, psig (bar) ^①	
-10 (-23) to 100 (37)	3000 (206)	3000 (206)
200 (93)	2575 (177)	2600 (179)
250 (121)	2450 (168)	2405 (165)
300 (148)	2325 (160)	—
375 (190)	2185 (150)	—

① To reduce the possibility of dislodging the O-ring in systems where pressure surges, shock, or pulses occur, for all 2C and 4C series valves and for 6C and 8C series valves with cracking pressures lower than 50 psi (3.5 bar), an optional inlet gasket is available. See page 14 for ordering information. Cracking and reseal pressures may decrease slightly from the ranges listed in this catalog.

Alternatively, CH or CP series valves should be considered.

CH Series

Ratings based on fluorocarbon FKM seals.

Material	316 SS	
Series	CH4, CH8	CH16
Temperature, °F (°C)	Working Pressure, psig (bar)	
-10 (-23) to 100 (37)	6000 (413) ^①	5000 (344) ^①
200 (93)	5160 (355)	4290 (295)
250 (121)	4910 (338)	4080 (281)
300 (148)	4660 (321)	3875 (266)
400 (204)	4280 (294)	3560 (245)

For more information about pressure ratings of valves with tube fitting end connections, see Swagelok *Tubing Data*, [MS-01-107](#).

① Pressure ratings may be limited by the end connection. See **Dimensions**, page 12.

C Series (12C and 16C)

Ratings based on fluorocarbon FKM O-rings in 316 stainless steel valves and Buna N O-rings in brass valves.

Material	316 SS	Brass
Temperature, °F (°C)	Working Pressure, psig (bar)	
-10 (-23) to 100 (37)	2000 (137)	1500 (103)
200 (93)	1715 (118)	1300 (89.5)
250 (121)	1630 (112)	1200 (82.6)
300 (148)	1545 (106)	—
375 (190)	1450 (99.9)	—

Cracking and Reseal Pressures at 70°F (20°C)

Cracking pressure—the inlet pressure at which the first indication of flow occurs (steady stream of bubbles).

Reseal pressure—the pressure at which there is no indication of flow.

Back pressure—the differential pressure between the inlet and outlet pressures.

⚠ For valves not actuated for a period of time, initial cracking pressure may be higher than the set cracking pressure.

C Series

Nominal Cracking Pressure psi (bar)	Cracking Pressure Range psi (bar)	Reseal Pressure psi (bar)
1/3 (0.03)	Up to 3 (0.21)	Up to 6 (0.42) back pressure
1 (0.07)	Up to 4 (0.28)	Up to 6 (0.42) back pressure
10 (0.69)	7 to 15 (0.49 to 1.1)	3 (0.21) or more inlet pressure
25 (1.8)	20 to 30 (1.4 to 2.1)	17 (1.2) or more inlet pressure

CH Series

Nominal Cracking Pressure psi (bar)	Cracking Pressure Range psi (bar)	Reseal Pressure psi (bar)
1/3 (0.03)	Up to 3 (0.21)	Up to 6 (0.42) back pressure
1 (0.07)	Up to 4 (0.28)	Up to 5 (0.35) back pressure
5 (0.35)	3 to 9 (0.21 to 0.63)	Up to 2 (0.14) back pressure
10 (0.69)	7 to 15 (0.49 to 1.1)	3 (0.21) or more inlet pressure
25 (1.8)	20 to 30 (1.4 to 2.1)	17 (1.2) or more inlet pressure

CP Series

Nominal Cracking Pressure psi (bar)	Cracking Pressure Range psi (bar)	Reseal Pressure psi (bar)
1/3 (0.03)	Up to 3 (0.21)	Up to 20 (1.4) back pressure
1 (0.07)	Up to 4 (0.28)	Up to 20 (1.4) back pressure
10 (0.69)	7 to 13 (0.49 to 0.90)	Up to 10 (0.69) back pressure
25 (1.8)	21 to 29 (1.5 to 2.0)	5 (0.35) or more inlet pressure

CA and CPA Series

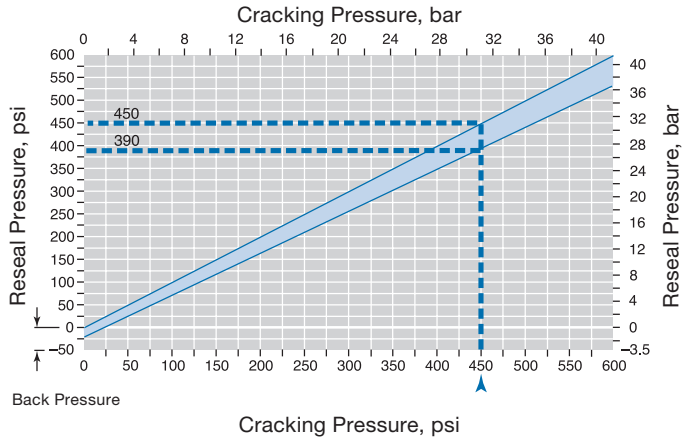

Materials of Construction

C and CA Series

Component	Valve Body Materials	
	316 SS	Brass
	Material Grade/ASTM Specification	
1 Inlet body	316 SS/A479	Brass 360/B16
2 Inlet gasket (CA series) <i>Inlet gasket (standard for 6C and 8C series with ≥ 50 psi [3.5 bar] spring; optional for 2C and 4C series and all other 6C and 8C series)</i>	PTFE-coated 316 SS/A240	
<i>Inlet gasket (12C and 16C series)</i>		
3 Insert (CA series)	316 SS/A479	Naval brass 485/B21
4 O-ring	Fluorocarbon FKM	Buna N
5 Poppet	316 SS/A479	Brass 360/B16
6 Spring	302 SS/A313	
7 Center body (CA series)	316 SS/A479	Brass 360/B16
8 Adjusting screw (CA series)	316 SS/A276	
9 Locking screw (CA series)		
10 Outlet gasket (CA series)	PTFE-coated 316 SS/A240	
11 Outlet body	316 SS/A479	Brass 360/B16
Wetted lubricant	<i>Silicone-based (C series); PTFE-based (CA series)</i>	
Nonwetted lubricant	Molybdenum disulfide-based	—

Wetted components listed in *italics*.

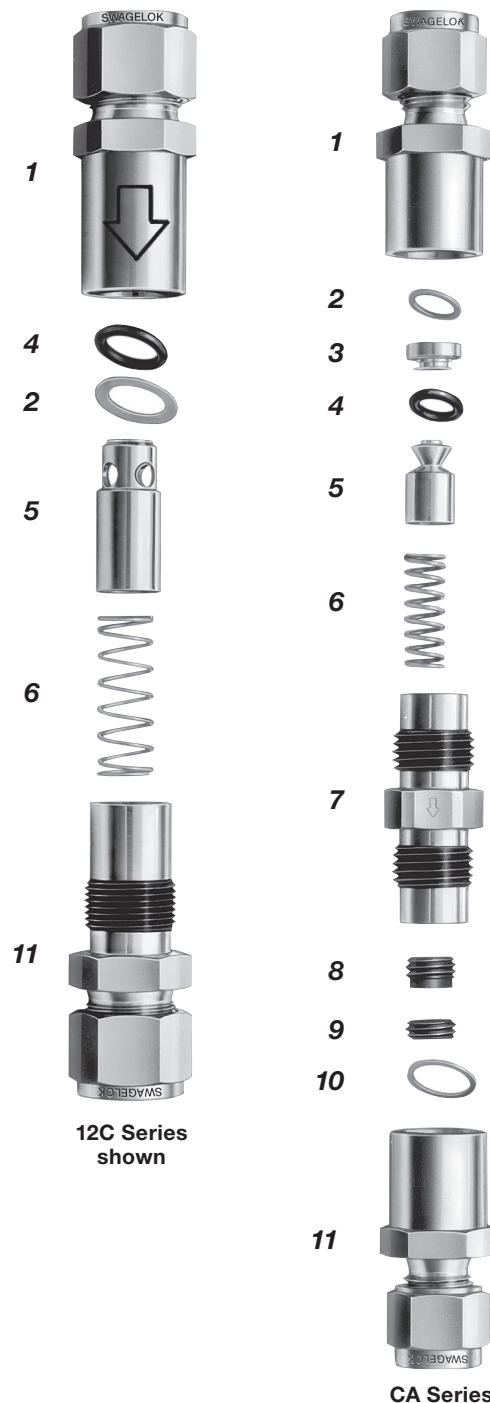

12C Series shown

CA Series

CH Series

Component	Material Grade/ASTM Specification
1 Inlet body	316 SS/A479
2 Poppet	Fluorocarbon FKM-bonded ^① 316 SS/A479
3 Poppet stop	316 SS/A240
4 Spring	302 SS/A313
5 O-ring	Fluorocarbon FKM
6 Backup ring	PTFE/D1710
7 Outlet body	316 SS/A479
Lubricant	PTFE-based

Wetted components listed in *italics*.

① Material Safety Data Sheet for bonding agent available on request.

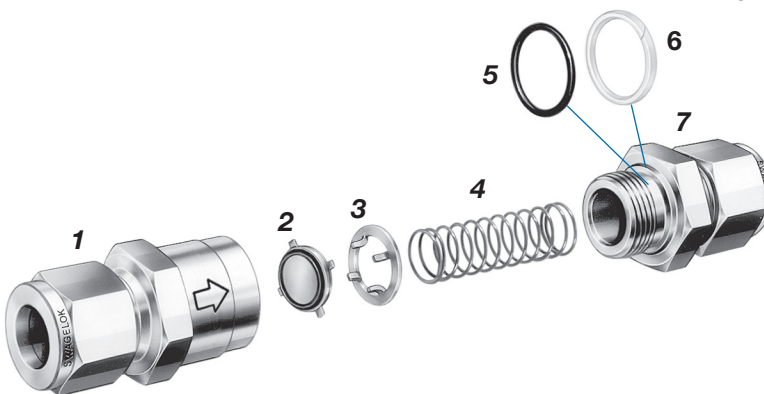

Materials of Construction

CP Series

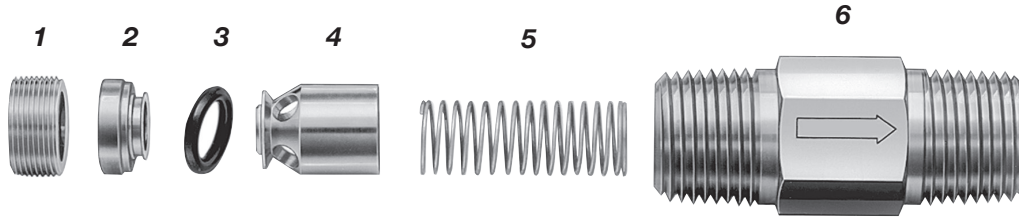

CPA Series

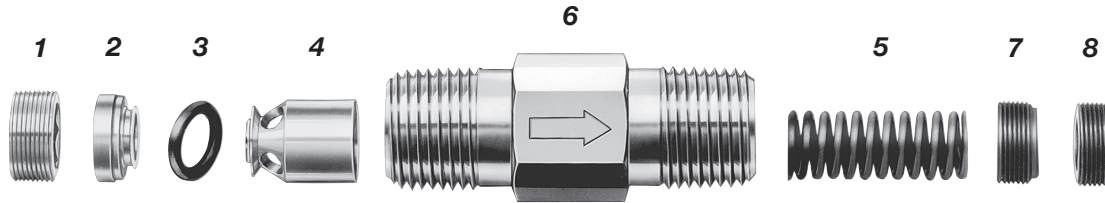

Component	Valve Body Materials				
	316 SS	Brass			
		4CP	8CP	4CPA	8CPA
	Material Grade/Specification				
1 Insert lock screw	316 SS/ASTM A276 or A479	<i>Brass CW710R/EN 12163</i>	<i>Brass 360/ASTM B16</i>	<i>Brass CW710R/EN 12163</i>	<i>Brass 360/ASTM B16</i>
2 Insert	316 SS/ASTM A479				
3 O-ring	<i>Fluorocarbon FKM</i>	<i>Buna N</i>			
4 Poppet	316 SS/ASTM A479	<i>Brass 360/ASTM B16</i>			
5 Spring	302 SS ^① /ASTM A313				
6 Body	316 SS/ASTM A479	<i>Brass 360/ASTM B16</i>			
7 Adjusting screw (CPA series)	316 SS/ASTM A276	—		316 SS/ASTM A276	<i>Brass 360^②/ASTM B16</i>
8 Locking screw (CPA series)					
Lubricant	<i>Silicone-based and PTFE-based (CP series) PTFE-based (CPA series)</i>	<i>Silicone-based and PTFE-based</i>		<i>PTFE-based</i>	

Wetted components listed in *italics*.

① Spring in 316 SS and brass 8CPA series valves is PTFE coated.

② Adjusting screw in valve with 150 or 350 psi (10.4 or 24.2 bar) spring is 316 SS.

Flow Data at 70°F (20°C)

The flow curves shown here were generated in optimal laboratory conditions. Flow results in individual applications may vary due to specific system parameters.

C Series

Nominal Cracking Pressures

2C, 6C, 12C, 16C Series — 1 psi (0.07 bar) — 10 psi (0.69 bar) — 25 psi (1.8 bar)
 4C, 8C Series — 1 psi (0.07 bar) — 10 psi (0.69 bar) — 25 psi (1.8 bar)

Air

2C, 4C Series

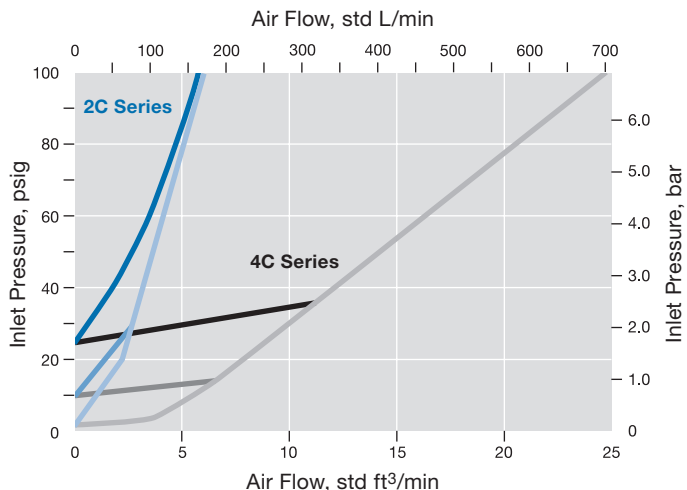

Water

2C, 4C Series

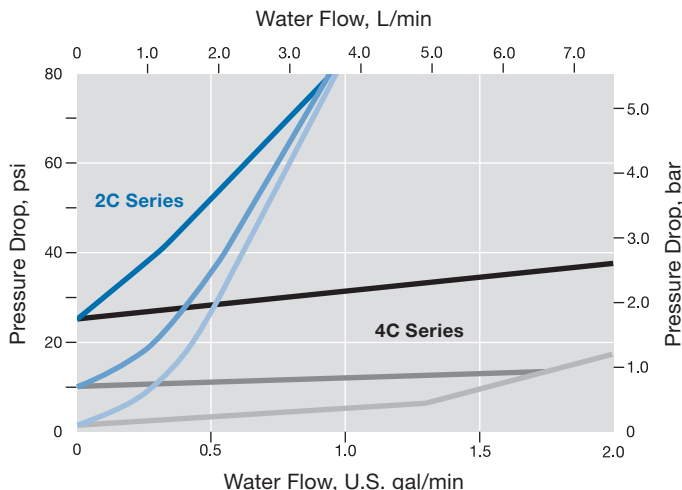

6C, 8C Series

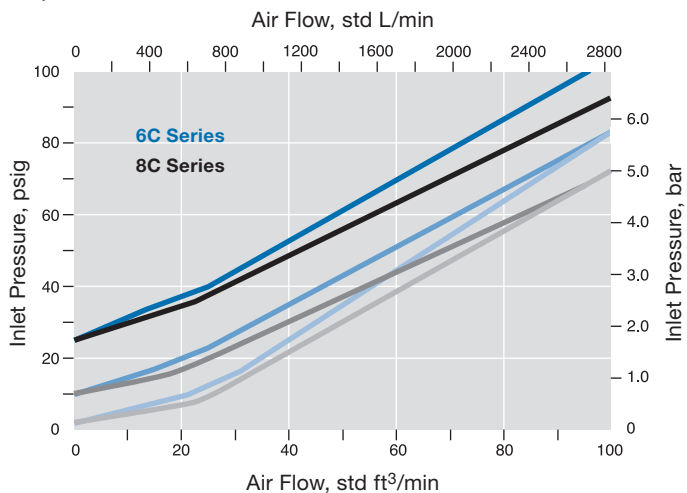

6C, 8C Series

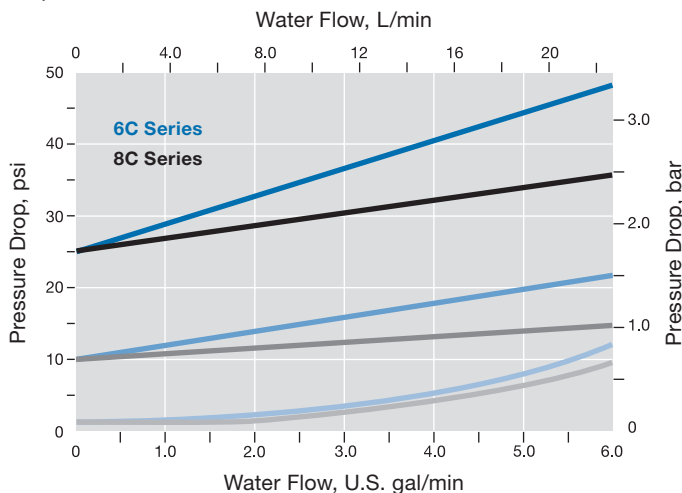

12C, 16C Series

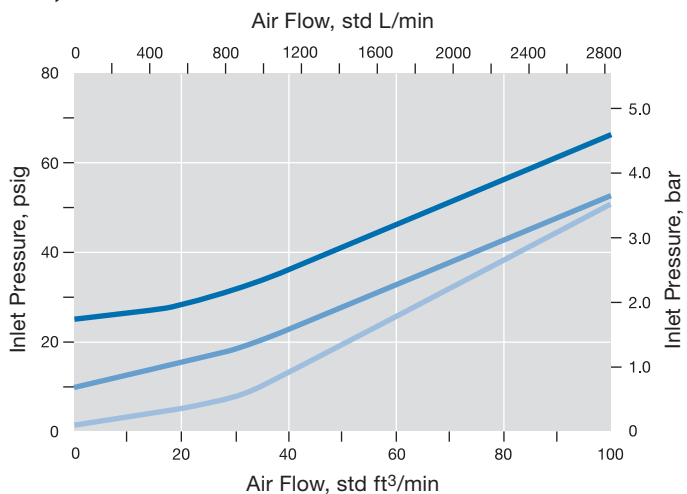

12C, 16C Series

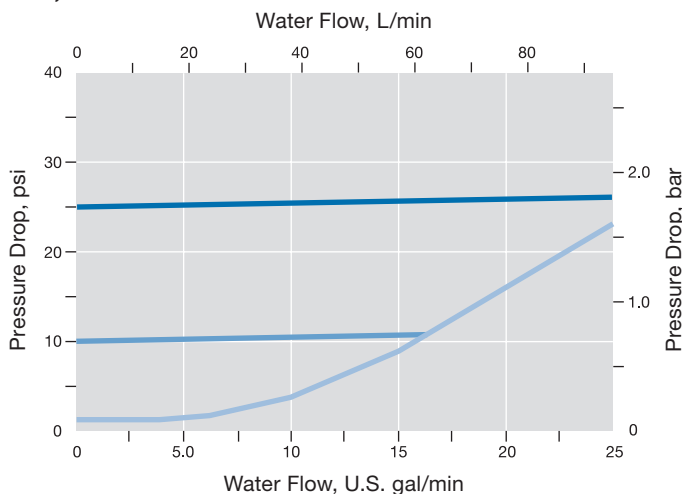

Flow Data at 70°F (20°C)

The flow curves shown here were generated in optimal laboratory conditions. Flow results in individual applications may vary due to specific system parameters.

CH Series

Nominal Cracking Pressures

— 1 psi (0.07 bar) — 10 psi (0.69 bar) — 25 psi (1.8 bar)

Air

CH4 Series

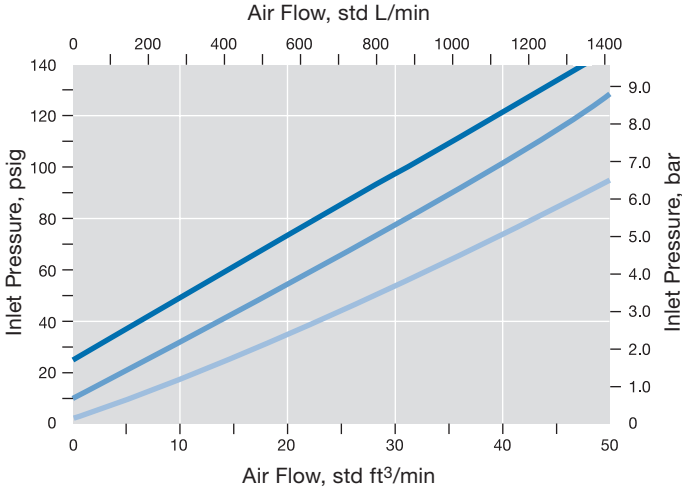

Water

CH4 Series

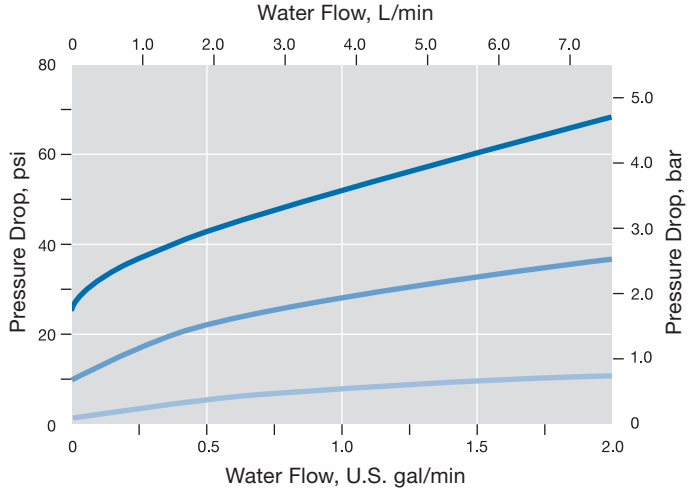

CH8 Series

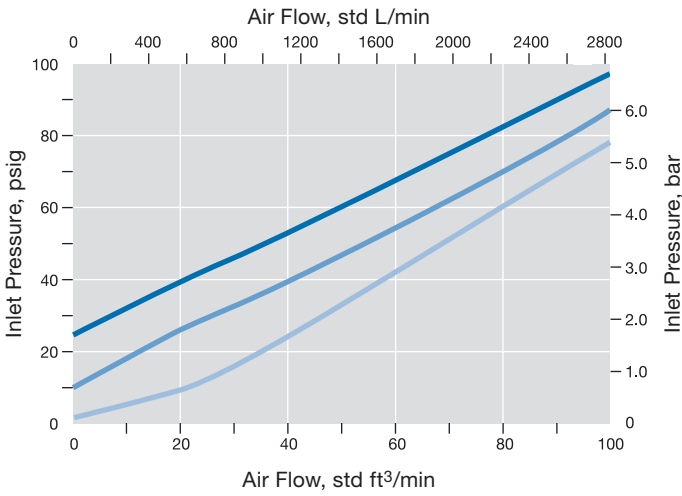

CH8 Series

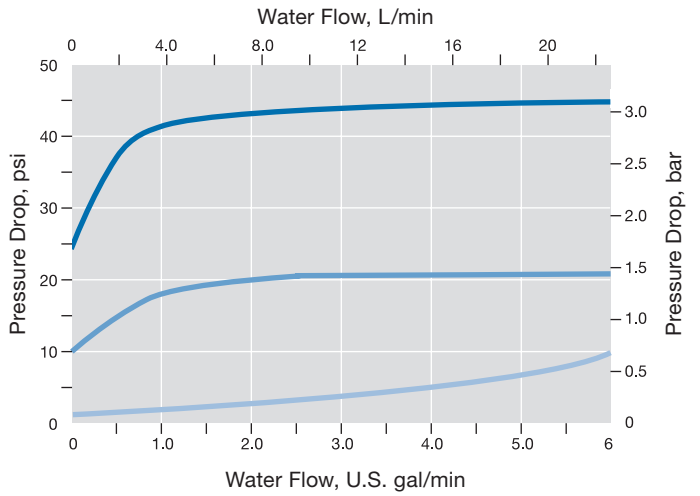

CH16 Series

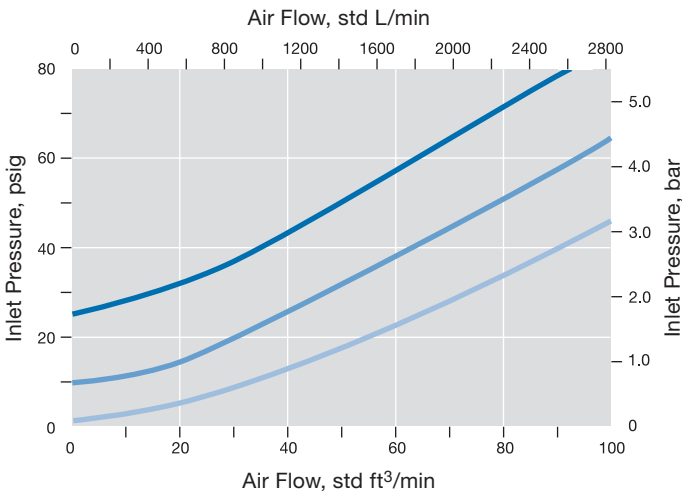

CH16 Series

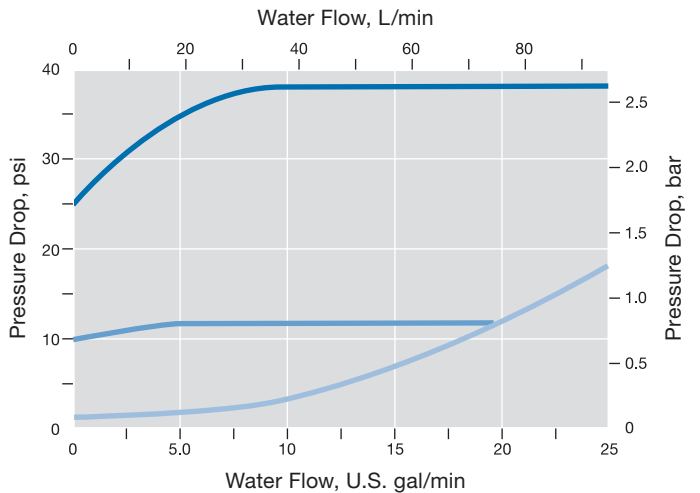

Flow Data at 70°F (20°C)

The flow curves shown here were generated in optimal laboratory conditions. Flow results in individual applications may vary due to specific system parameters.

CA and CPA Series

Nominal Cracking Pressures

— 3 psi (0.21 bar) — 50 psi (3.5 bar) — 150 psi (10.4 bar) — 350 psi (24.2 bar)

Air

CA Series

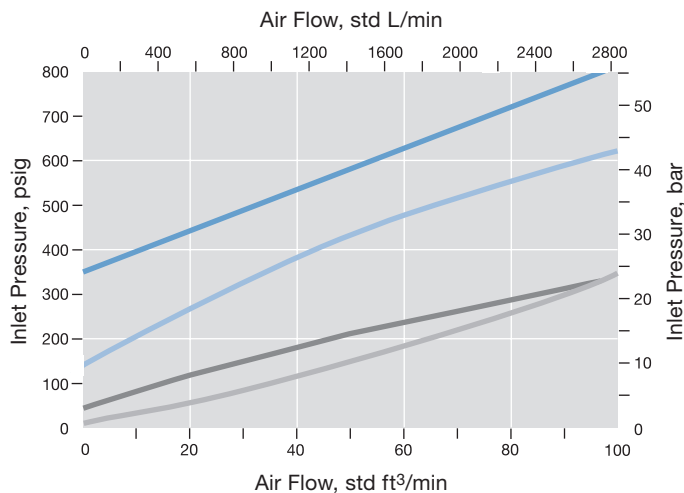

Water

CA Series

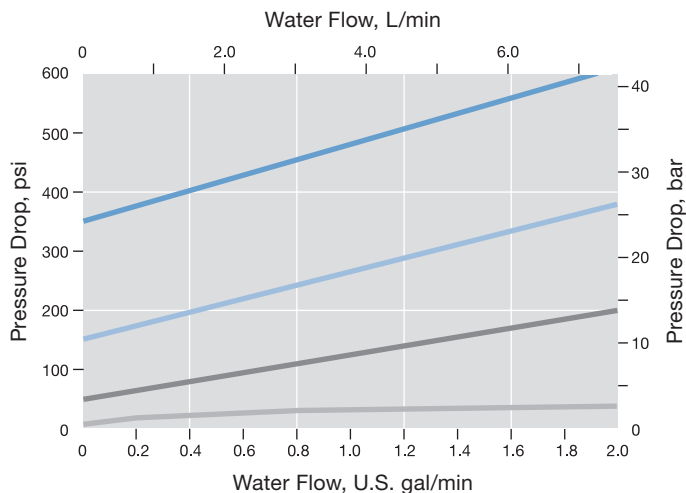

4CPA Series

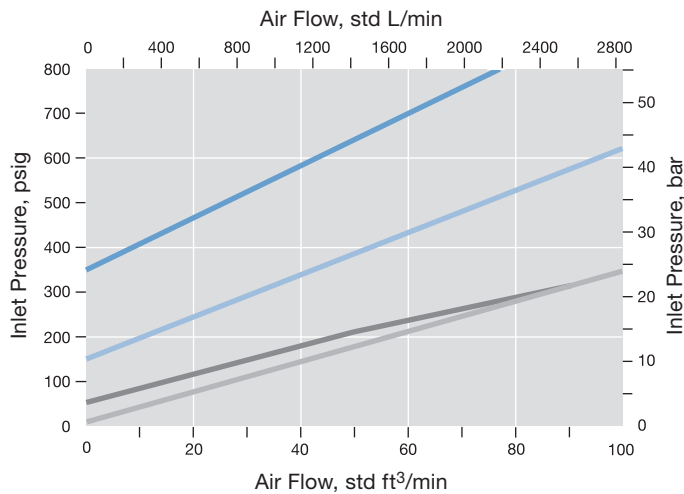

4CPA Series

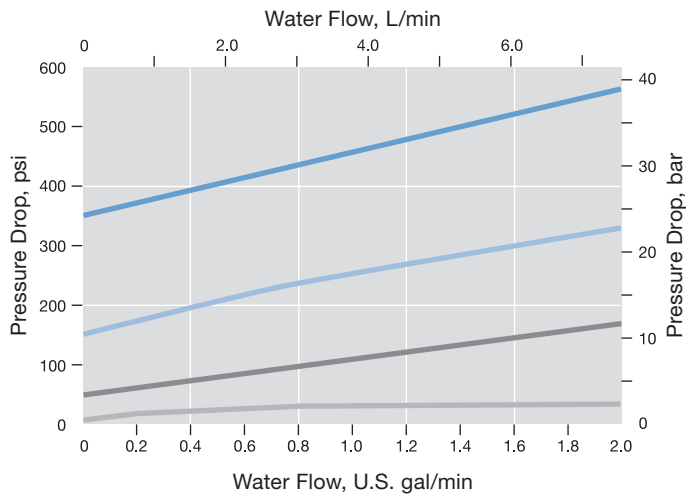

8CPA Series

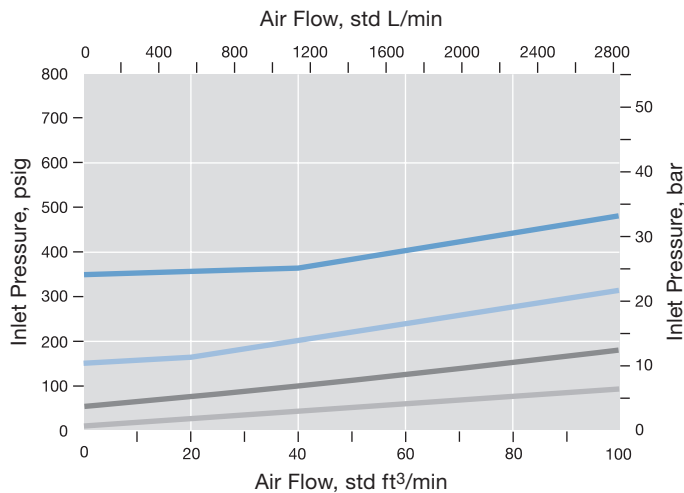

8CPA Series

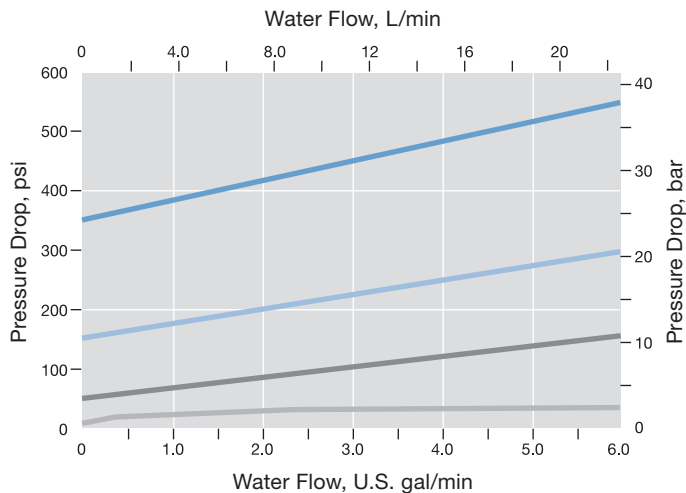

Flow Data at 70°F (20°C)

The flow curves shown here were generated in optimal laboratory conditions. Flow results in individual applications may vary due to specific system parameters.

CP Series

Nominal Cracking Pressures

— 1 psi (0.07 bar) — 10 psi (0.69 bar) — 25 psi (1.8 bar)

Air

4CP Series

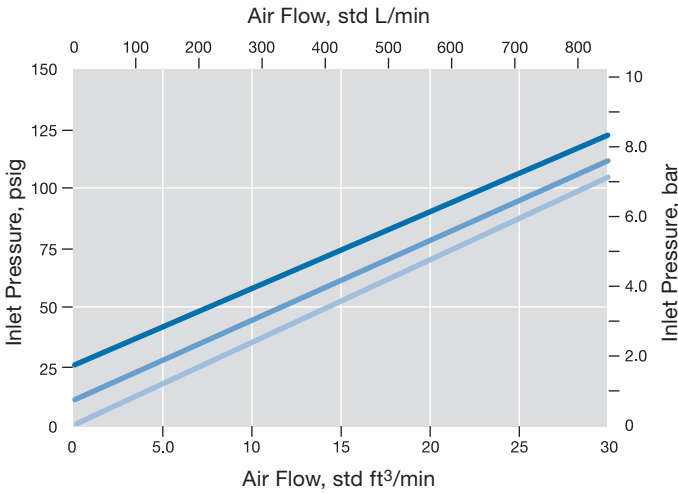

Water

4CP Series

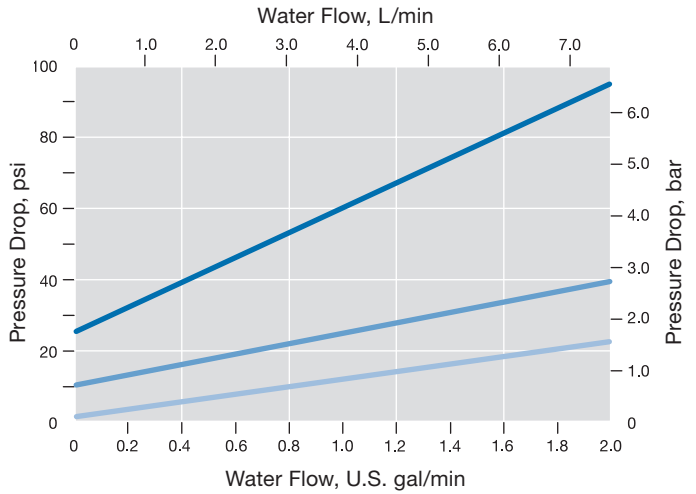

8CP Series

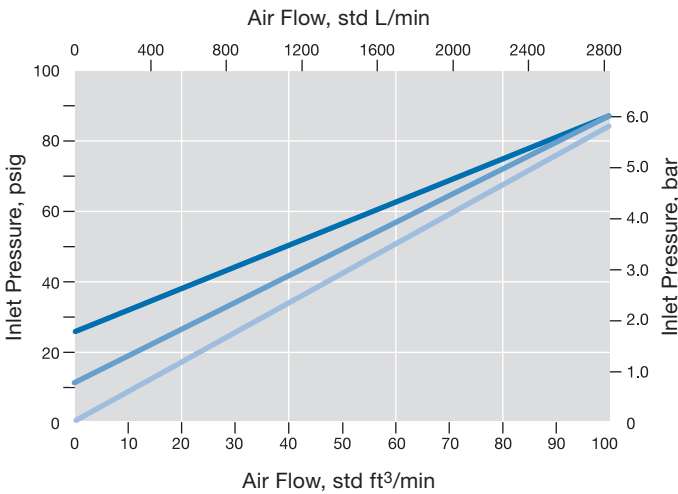

8CP Series

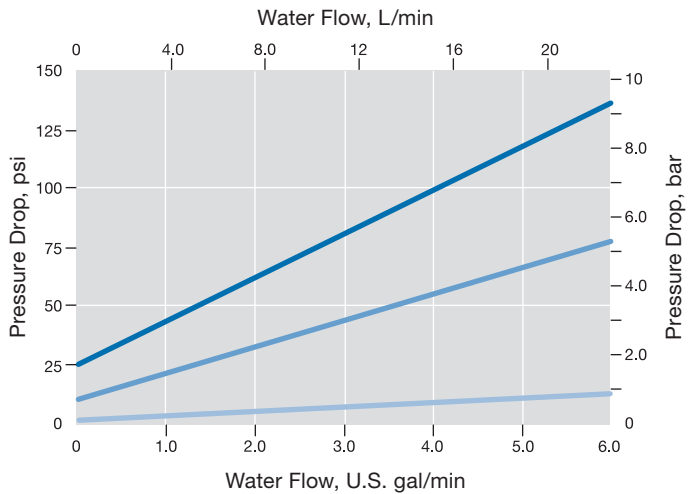

Testing

Every C, CA, CH, CP, and CPA series check valve is factory tested for crack and reseal performance with a liquid leak detector.

Check valves with fixed cracking pressures, C, CP, and CH series, are cycled six times prior to testing. Every valve is tested to ensure it seals within 5 seconds at the appropriate reseal pressure.

Check valves with adjustable cracking pressures, CA and CPA series, are tested at two pressure points. Every valve is tested at a low-pressure setting and at a high-pressure setting. All valves must seal within 5 seconds at the appropriate reseal pressure.

Cleaning and Packaging

Every C, CA, and CH series check valve with VCR® or VCO® end connections is processed in accordance with Swagelok *Special Cleaning and Packaging (SC-11)*, [MS-06-63](#), to ensure compliance with product cleanliness requirements as stated in ASTM G93 Level C.

All other C, CA, and CH series check valves, as well as every CP and CPA series check valve, are cleaned in accordance with Swagelok *Standard Cleaning and Packaging (SC-10)*, [MS-06-62](#).

Dimensions

Dimensions, shown with Swagelok tube fitting nuts finger-tight, are for reference only and are subject to change.

C Series

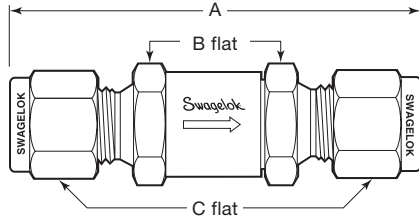

CA Series

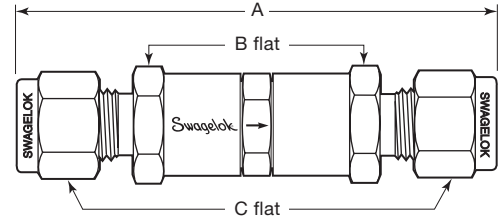

End Connections		Basic Ordering Number	Series	Dimensions, in. (mm)		
Inlet/Outlet	Size			A	B	C
Fixed Cracking Pressure, C Series						
Fractional Swagelok tube fittings	1/8 in.	SS-2C-	2C	2.14 (54.3)	5/8	7/16
	1/4 in.	SS-4C-	4C	2.35 (59.7)		9/16
	3/8 in.	SS-6C-	6C	3.17 (80.5)	7/8	11/16
	1/2 in.	SS-8C-	8C	3.42 (86.9)		7/8
	3/4 in.	SS-12C-	12C	4.32 (110)	1 1/4	1 1/8
	1 in.	SS-16C-	16C	4.74 (120)	1 3/8	1 1/2
Metric Swagelok tube fittings	6 mm	SS-6C-MM-	4C	2.36 (59.9)	5/8	(14)
	10 mm	SS-10C-MM-	8C	3.32 (84.3)	7/8	(19)
	12 mm	SS-12C-MM-		3.42 (86.9)		(22)
Female NPT	1/8 in.	SS-2C4-	2C	1.89 (48.0)	5/8	-
	1/4 in.	SS-4C4-	4C	2.15 (54.6)	3/4	
	3/8 in.	SS-6C4-	6C	2.98 (75.7)	7/8	
	1/2 in.	SS-8C4-	8C	3.58 (90.9)	1 1/16	
	3/4 in.	SS-12C4-	12C	4.08 (104)	1 1/4	
	1 in.	SS-16C4-	16C	4.84 (123)	1 5/8	
Male NPT	1/8 in.	SS-2C2-	2C	1.71 (43.4)	5/8	-
	1/4 in.	SS-4C2-	4C	2.09 (53.1)		
	3/8 in.	SS-6C2-	6C	2.78 (70.6)	7/8	
	1/2 in.	SS-8C2-	8C	3.16 (80.3)		
	3/4 in.	SS-12C2-	12C	4.08 (104)	1 1/4	
	1 in.	SS-16C2-	16C	4.52 (115)	1 5/8	
Male NPT/ Swagelok tube fitting	1/4 in.	SS-4C1-	4C	2.22 (56.4)	5/8	9/16
Male VCR fittings	1/4 in.	SS-4C-VCR-	4C	2.21 (56.1)	5/8	-
	1/2 in.	SS-8C-VCR-	8C	3.56 (90.4)	15/16	
	3/4 in.	SS-12C-VCR-	12C	4.64 (118)	1 5/8	
	1 in.	SS-16C-VCR-	16C	4.76 (121)		
Adjustable Cracking Pressure, CA Series						
Swagelok tube fittings	1/4 in.	SS-4CA-	CA	3.23 (82.0)	5/8	9/16
	6 mm	SS-6CA-MM-				(14)
	8 mm	SS-8CA-MM-				(16)
Male NPT/ Swagelok tube fitting	1/4 in.	SS-4CA1-		3.12 (79.2)		9/16
Male VCR fittings	1/4 in.	SS-4CA-VCR-		3.09 (78.5)		-

Ordering Information

Basic ordering numbers specify stainless steel material. To order brass, replace **SS** with **B** in the basic ordering number.

Example: **B-2C-**

C Series

To order, add a cracking pressure designator to the basic ordering number.

Cracking Pressure psi (bar)	Designator
1/3 (0.03)	1/3
1 (0.07)	1
10 (0.69)	10
25 (1.8)	25

Example: **SS-2C-1/3**

CA Series

To order, add a cracking pressure range designator to the basic ordering number.

Cracking Pressure psi (bar)	Designator
3 to 50 (0.21 to 3.5)	3
50 to 150 (3.5 to 10.4)	50
150 to 350 (10.4 to 24.2)	150
350 to 600 (24.2 to 41.4)	350

Example: **SS-4CA-3**

⚠ Check valves are designed for directional flow control only. Swagelok check valves should never be used as code safety relief devices.

Dimensions

Dimensions, shown with Swagelok tube fitting nuts finger-tight, are for reference only and are subject to change.

End Connections		Pressure Rating at 100°F (37°C) psig (bar)	Basic Ordering Number	Series	Dimensions in. (mm)		
Type	Size				A	B	
Fractional Swagelok tube fitting	1/8 in.	6000 (413)	SS-CHS2-	CH4	2.27 (57.7)	11/16	
	1/4 in.		SS-CHS4-		2.43 (61.7)		
	3/8 in.		SS-CHS6-	CH8	2.75 (69.9)		
	1/2 in.		SS-CHS8-		2.96 (75.2)		
	3/4 in.	5000 (344)	SS-CHS12-	CH16	3.52 (89.4)		1 5/8
	1 in.	4700 (323)	SS-CHS16-		3.88 (98.6)		
Metric Swagelok tube fitting	6 mm	6000 (413)	SS-CHS6MM-	CH4	2.43 (61.7)	11/16	
	8 mm		SS-CHS8MM-	CH8	2.70 (68.6)		
	10 mm		SS-CHS10MM-		2.80 (71.1)		
	12 mm		SS-CHS12MM-	2.96 (75.2)			
	22 mm	4900 (337)	SS-CHS22MM-	CH16	3.48 (88.4)		1 5/8
	25 mm	4600 (316)	SS-CHS25MM-		3.88 (98.6)		
Female NPT	1/4 in.	6000 (413)	SS-CHF4-	CH4	2.13 (54.1)	11/16	
	3/8 in.	5300 (365)	SS-CHF6-	CH8	2.55 (64.8)	1	
	1/2 in.	4900 (337)	SS-CHF8-		3.03 (77.0)	1 1/16	
	3/4 in.	4600 (316)	SS-CHF12-	CH16	3.23 (82.0)	1 5/8	
	1 in.	4400 (303)	SS-CHF16-		3.83 (97.3)		
Male NPT	1/8 in.	6000 (413)	SS-CHM2-	CH4	1.79 (45.5)	11/16	
	1/4 in.		SS-CHM4-		2.17 (55.1)		
	3/8 in.		SS-CHM6-	CH8	2.36 (59.9)		1
	1/2 in.		SS-CHM8-		2.73 (69.3)		
	3/4 in.	5000 (344)	SS-CHM12-	CH16	3.29 (83.6)		1 5/8
	1 in.	4400 (303)	SS-CHM16-		3.67 (93.2)		
Female ISO ^①	1/4 in.	6000 (413)	SS-CHF4RT-	CH4	2.28 (57.9)	11/16	
	1/2 in.	5100 (351)	SS-CHF8RT-	CH8	3.29 (83.6)	1 1/16	
	3/4 in.	4800 (330)	SS-CHF12RT-	CH16	3.55 (90.2)	1 5/8	
	1 in.	4400 (303)	SS-CHF16RT-		3.83 (97.3)		
Male ISO ^①	1/4 in.	6000 (413)	SS-CHM4RT-	CH4	2.17 (55.1)	11/16	
	1/2 in.		SS-CHM8RT-	CH8	2.73 (69.3)	1	
	3/4 in.	5000 (344)	SS-CHM12RT-	CH16	3.29 (83.6)	1 5/8	
	1 in.		SS-CHM16RT-		3.67 (93.2)		
Female SAE/MS	1/2 in.	4600 (316)	SS-CHF8ST-	CH8	2.74 (69.6)	1	
Male SAE/MS	1/2 in.	4600 (316)	SS-CHM8ST-		2.48 (63.0)		
Male VCO fitting	1/4 in.	6000 (413)	SS-CHVCO4-	CH4	1.98 (50.3)	11/16	
	1/2 in.		SS-CHVCO8-	CH8	2.35 (59.7)	1	
	3/4 in.	5000 (344)	SS-CHVCO12-	CH16	2.90 (73.7)	1 5/8	
	1 in.		SS-CHVCO16-				
Male VCR fitting	1/4 in.	6000 (413)	SS-CHVCR4-	CH4	2.28 (57.9)	11/16	
	1/2 in.	4300 (296)	SS-CHVCR8-	CH8	2.73 (69.3)	1	
	3/4 in.	3700 (254)	SS-CHVCR12-	CH16	3.78 (96.0)	1 5/8	

① See specifications ISO 7/1, BS EN 10226-1, DIN 2999, JIS B0203.

CH Series

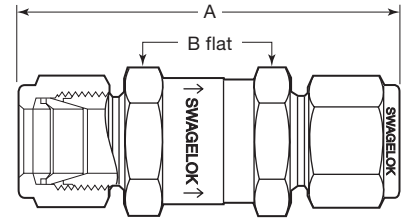

Ordering Information

To order, add a cracking pressure designator to the basic ordering number.

Cracking Pressure psi (bar)	Designator
1/3 (0.03)	1/3
1 (0.07)	1
5 (0.35)	5
10 (0.69)	10
25 (1.8)	25

Example: SS-CHS2-1/3

⚠ Check valves are designed for directional flow control only. Swagelok check valves should never be used as code safety relief devices.

Dimensions

Dimensions, shown with Swagelok tube fitting nuts finger-tight, are for reference only and are subject to change.

CP and CPA Series

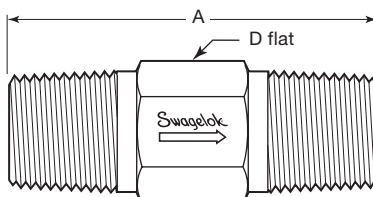

End Connections		Basic Ordering Number	Series	Dimensions, in. (mm)	
Inlet/Outlet	Size			A	D
Fixed Cracking Pressure, CP Series					
Female NPT	1/4 in.	SS-4CP4-	4CP	2.41 (61.2)	3/4
	1/2 in.	SS-8CP4-	8CP	3.71 (94.2)	1 1/16
Male NPT	1/4 in.	SS-4CP2-	4CP	1.62 (41.1)	9/16
	1/2 in.	SS-8CP2-	8CP	2.28 (57.9)	7/8
Female/male NPT	1/4 in.	SS-4CP6-	4CP	2.29 (58.2)	3/4
Male/female NPT	1/4 in.	SS-4CP5-		1.75 (44.4)	3/4
	1/2 in.	SS-8CP5-	8CP	2.83 (71.9)	1 1/16
Female ISO ^①	1/4 in.	SS-4CP4-RT-	4CP	2.54 (64.5)	3/4
Male ISO ^①	1/4 in.	SS-4CP2-RT-		1.62 (41.1)	9/16
Adjustable Cracking Pressure, CPA Series					
Female NPT	1/4 in.	SS-4CPA4-	4CPA	2.98 (75.7)	3/4
Male NPT	1/4 in.	SS-4CPA2-		1.62 (41.1)	9/16
	1/2 in.	SS-8CPA2-	8CPA	2.56 (65.0)	7/8
Male ISO ^①	1/4 in.	SS-4CPA2-RT-	4CPA	1.62 (41.1)	9/16
	1/2 in.	SS-8CPA2-RT-	8CPA	2.56 (65.0)	7/8

^① See specifications ISO 7/1, BS EN 10226-1, DIN 2999, and JIS B0203.

Ordering Information

Basic ordering numbers specify stainless steel material. To order brass, replace **SS** with **B** in the basic ordering number.

Example: **B-4CP4-**

CP Series

To order, add a cracking pressure designator to the basic ordering number.

Cracking Pressure psi (bar)	Designator
1/3 (0.03)	1/3
1 (0.07)	1
10 (0.69)	10
25 (1.8)	25

Example: **B-4CP4-1/3**

CPA Series

To order, add a cracking pressure range designator to the basic ordering number.

Cracking Pressure psi (bar)	Designator
3 to 50 (0.21 to 3.5)	3
50 to 150 (3.5 to 10.4)	50
150 to 350 (10.4 to 24.2)	150
350 to 600 (24.2 to 41.4)	350

Example: **SS-4CPA4-3**

⚠ Check valves are designed for directional flow control only. Swagelok check valves should never be used as code safety relief devices.

Options and Accessories

Seal Materials (All Series)

Fluorocarbon FKM O-rings are standard in 316 stainless steel valves; Buna N O-rings are standard in brass valves. Other elastomer seals (poppet bonding material and O-ring) are available. To order, insert the seal material designator into the valve ordering number.

Seal Material	Designator	Temperature Rating °F (°C)
Buna N	-BU	-10 to 250 (-23 to 121)
Ethylene propylene	-EP	-50 to 300 (-45 to 148)
Fluorocarbon FKM	-VI	-10 to 375 (-23 to 190) ^①
Neoprene	-NE	-40 to 250 (-40 to 121)

① -10 to 400°F (-23 to 204°C) for CH series.

Example: B-2C-**VI**-1/3

Additional seal materials are available. Contact your authorized Swagelok representative for details.

Special Alloys (All Series)

Springs of alloy 400 or alloy C-276 are available in some sizes. Valve bodies of alloy 400, carbon steel, aluminum, or other alloys are available in some sizes. Contact your authorized Swagelok representative for more information.

PTFE-Coated Springs (C, CA, CP, and CPA Series)

Springs with PTFE coating are available in some sizes. Contact your authorized Swagelok representative for more information.

Inlet Gaskets (2C, 4C, 6C, and 8C Series)

PTFE-coated 316 stainless steel inlet gaskets are available for 2C, 4C, 6C, and 8C series valves to reduce the possibility of dislodging the O-ring in systems where pressure surges, shock, or pulses occur. Gaskets are standard for select valves; see the table below for details.

Cracking Pressure psig (bar)	Inlet Gasket		
	2C, 4C Series	6C, 8C Series	12C, 16C Series
< 50 (3.5)	Optional	Optional	Standard
> 50 (3.5)	Optional	Standard	Standard

To order an inlet gasket, if it is not standard, insert **-FG** into the valve ordering number.

Example: SS-4C-**FG**-1

Deflector Caps (4C, 8C, CP, and CPA Series)

A polyethylene deflector cap is available for 4C, 8C, CP, and CPA series valves with male NPT end connections. The deflector cap deflects flow from direct contact with personnel and prevents atmospheric contaminants from entering the valve. The deflector cap screws easily onto the male NPT outlet end of the valve. Maximum rating is 300 psig at 100°F (20.6 bar at 37°C).

To order, insert **-DG** for a green cap or **-DR** for a red cap into the ordering number.

Example: SS-4CPA2-**DR**-3

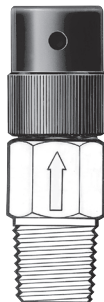

Sour Gas Valves (CH Series)

CH series valves are available for sour gas service. Materials are selected in accordance with NACE MR0175/ISO 15156.

Technical Data

Pressure Rating at 70°F (20°C)

5000 psig (344 bar)

Temperature Rating

-50 to 300°F (-45 to 148°C)

Nominal Cracking Pressures

1/3, 1, and 5 psi (0.03, 0.07, and 0.35 bar)

End Connections

1/4, 3/8, and 1/2 in. Swagelok tube fittings

Materials of Construction

Body, poppet—alloy 400/B164

Seals—ethylene propylene

Backup ring—PTFE

Spring—alloy X-750/AMS 5699

All other materials and lubricant same as standard product.

See **Materials of Construction**, page 5.

Ordering Information

To order, replace **SS** with **M** and insert **-SG** into the ordering number.

Example: **M**-CHS4-**SG**-1/3

Valves With ECE R110-Type Approval (CH Series)

Stainless steel CH series check valves with Buna C seals are available with ECE R110-type approval for use in alternative fuel service.

- Temperature rating: -40 to 185°F (-40 to 85°C)
- Pressure rating within the range: 3770 psig (260 bar)

To order, add **-11670** to a standard valve ordering number.

Example: SS-CHS8-1/3-**11670**

Special Cleaning and Packaging (SC-11)

Every C, CA, and CH series check valve with VCR or VCO end connections is processed in accordance with Swagelok *Special Cleaning and Packaging (SC-11)*, [MS-06-63](#), to ensure compliance with product cleanliness requirements stated in ASTM G93 Level C.

To order special cleaning and packaging for C, CA, and CH series check valves with other end connections, add **-SC11** to the ordering number.

Example: SS-2C-1/3-**SC11**

Oxygen Service Hazards

For more information about hazards and risks of oxygen-enriched systems, see the Swagelok *Oxygen System Safety* technical report, [MS-06-13](#).

Maintenance Kits



C, CP, CA, and CPA Series Seal Kits

Kits contain O-ring and instructions. Select a kit ordering number. To order PTFE seal kits, replace the material designator with **T** and omit the durometer number.

Example: T-4C-K4

Valve Series	Uniform O-Ring Size	Kit Ordering Number
Fixed Cracking Pressures: 1/3, 1, 10, and 25 psi (0.03, 0.07, 0.69, and 1.8 bar)		
2C, 4C	009	NEO70-4C-K4
		VI70-4C-K4
		BU80-4C-K4
		EP80-4C-K4
4CP	009	NEO60-4C-K4
		VI60-4C-K4
		BU60-4C-K4
		EP60-4C-K4
6C, 8C	111	NEO70-8C-K4
		VI70-8C-K4
		BU70-8C-K4
		EP70-8C-K4
8CP	110	NEO70-8CP-K4
		VI70-8CP-K4
		BU70-8CP-K4
		EP70-8CP-K4
12C, 16C	114	NEO70-14C-K4
		VI70-14C-K4
		BU70-14C-K4
		EP70-14C-K4
Adjustable Cracking Pressures: 3 to 150 psi (0.21 to 10.4 bar)		
CA, 4CPA	009	NEO70-4C-K4
		VI70-4C-K4
		BU70-4C-K4
		EP70-4C-K4
8CPA	110	NEO70-8CP-K4
		VI70-8CP-K4
		BU70-8CP-K4
		EP70-8CP-K4
Adjustable Cracking Pressures: 150 to 600 psi (10.4 to 41.4 bar)		
CA, 4CPA	009	NEO90-4C-K4
		VI90-4C-K4
		BU90-4C-K4
		EP90-4C-K4
8CPA	110	NEO90-8CP-K4
		VI90-8CP-K4
		BU90-8CP-K4
		EP90-8CP-K4

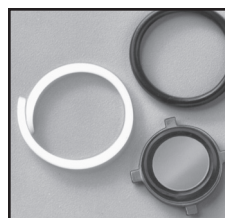

CH Series Seal Kits

Kits contain bonded poppet, body seal O-ring, PTFE backup ring, and instructions. Select a basic kit ordering number and add a seal material designator.

Example: SS-3K-CH4-VI

Valve Series	Valve Body Material	Basic Kit Ordering Number
CH4	316 SS	SS-3K-CH4-
	Alloy 400	M-3K-CH4-
CH8	316 SS	SS-3K-CH8-
	Alloy 400	M-3K-CH8-
CH16	316 SS	SS-3K-CH16-

Seal Material	Designator
Buna N	BN
Ethylene propylene	EP
Fluorocarbon FKM	VI
Neoprene	NE

CA and C Series Metal Gasket Kits

Kits contain PTFE-coated gasket(s) and instructions. Select a basic kit ordering number and add a gasket material designator.

Example: SS-8C-K6

Valve Series	Basic Kit Ordering Number
2C, 4C (1 gasket) ^①	-4C-K6
6C, 8C (1 gasket) ^①	-8C-K6
12C, 16C (1 gasket)	-14C-K6
CA (1 inlet gasket, 1 outlet gasket)	-4CA-K6

^① Gasket is available for 2C, 4C, 6C, and 8C series valves for use in systems where pressure surges, shock, or pulses occur and is required in 6C and 8C series valves with 50 psi (3.5 bar) or higher spring cracking pressure.

Gasket Material	Designator
316 SS	SS
Alloy 400 ^①	M
Aluminum ^②	A

^① Not available for 6C, 8C, and CA series valves.

^② Not available for 2C, 4C, 6C, 8C, and CA series valves.

Maintenance Kits

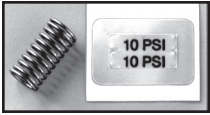

C, CP, CA, and CPA Series Spring Kits

Kits contain spring, two cracking pressure labels, and instructions. Select a basic kit ordering number and add a spring material designator.

Example: **302-4C-K2-1/3**

To order a kit with a PTFE-coated spring, add **T** to the kit ordering number.

Example: 302-4C-K2-1/3T

Valve Series	Cracking Pressure psi (bar)	Basic Kit Ordering Number
2C, 4C 4CP	1/3 (0.03)	-4C-K2-1/3
	1 (0.07)	-4C-K2-1
	10 (0.69)	-4C-K2-10
	25 (1.8)	-4C-K2-25
6C, 8C, 8CP	1/3 (0.03)	-8C-K2-1/3
	1 (0.07)	-8C-K2-1
	10 (0.69)	-8C-K2-10
	25 (1.8)	-8C-K2-25
12C, 16C	1/3 (0.03)	-14C-K2-1/3
	1 (0.07)	-14C-K2-1
	10 (0.69)	-14C-K2-10
	25 (1.8)	-14C-K2-25

Valve Series	Cracking Pressure psi (bar)	Basic Kit Ordering Number
CA, 4CPA	3 to 50 (0.21 to 3.5)	-4CA-K2-3
	50 to 150 (3.5 to 10.4)	-4CA-K2-50
	150 to 350 (10.4 to 24.2)	-4CA-K2-150
	350 to 600 (24.2 to 41.4)	-4CA-K2-350
8CPA	3 to 50 (0.21 to 3.5)	-8CA-K2-3
	50 to 150 (3.5 to 10.4)	-8CA-K2-50
	150 to 350 (10.4 to 24.2)	-8CA-K2-150
	350 to 600 (24.2 to 41.4)	-8CA-K2-350

Spring Material	Designator
302 SS	302
Alloy 400 ^①	M

① Not available for CA or CPA series valves.



CH Series Spring Kits

Kits contain spring, two cracking pressure labels, and instructions. Select a basic kit ordering number and add a cracking pressure designator.

Example: **302-13K-CH4-1/3**

Valve Series	Valve Body Material	Basic Kit Ordering Number
CH4	316 SS	302-13K-CH4-
	Alloy 400	M-13K-CH4-
CH8	316 SS	302-13K-CH8-
	Alloy 400	M-13K-CH8-
CH16	316 SS	302-13K-CH16-

Cracking Pressure psi (bar)	Designator
1/3 (0.03)	1/3
1 (0.07)	1
5 (0.35)	5
10 (0.69)	10
25 (1.8)	25



4C, 8C, CP, and CPA Series Deflector Cap Kits

Each kit contains one polyethylene deflector cap in red or green.

Male NPT	Kit Ordering Number	
	Red	Green
1/4 in.	P-4CP4-K12-RD	P-4CP4-K12-GR
1/2 in.	P-8CP4-K12-RD	P-8CP4-K12-GR

Safe Product Selection

When selecting a product, the total system design must be considered to ensure safe, trouble-free performance. Function, material compatibility, adequate ratings, proper installation, operation, and maintenance are the responsibilities of the system designer and user.

⚠ WARNING

Do not mix/interchange Swagelok products or components not governed by industrial design standards, including Swagelok tube fitting end connections, with those of other manufacturers.

Warranty Information

Swagelok products are backed by The Swagelok Limited Lifetime Warranty. For a copy, visit swagelok.com or contact your authorized Swagelok representative.